

## **In Situ Formed Acetal Facilitated Direct Michael addition of Unactivated Ketones**

**Srinivasa Rao Koppolu and Rengarajan Balamurugan\***

School of Chemistry, University of Hyderabad, Prof. C. R. Rao road, Gachibowli, Hyderabad 500046 INDIA

E-mail: [rpsc@uohyd.ernet.in](mailto:rpsc@uohyd.ernet.in)

**Submitted to New J. Chem**

**Supporting Information**

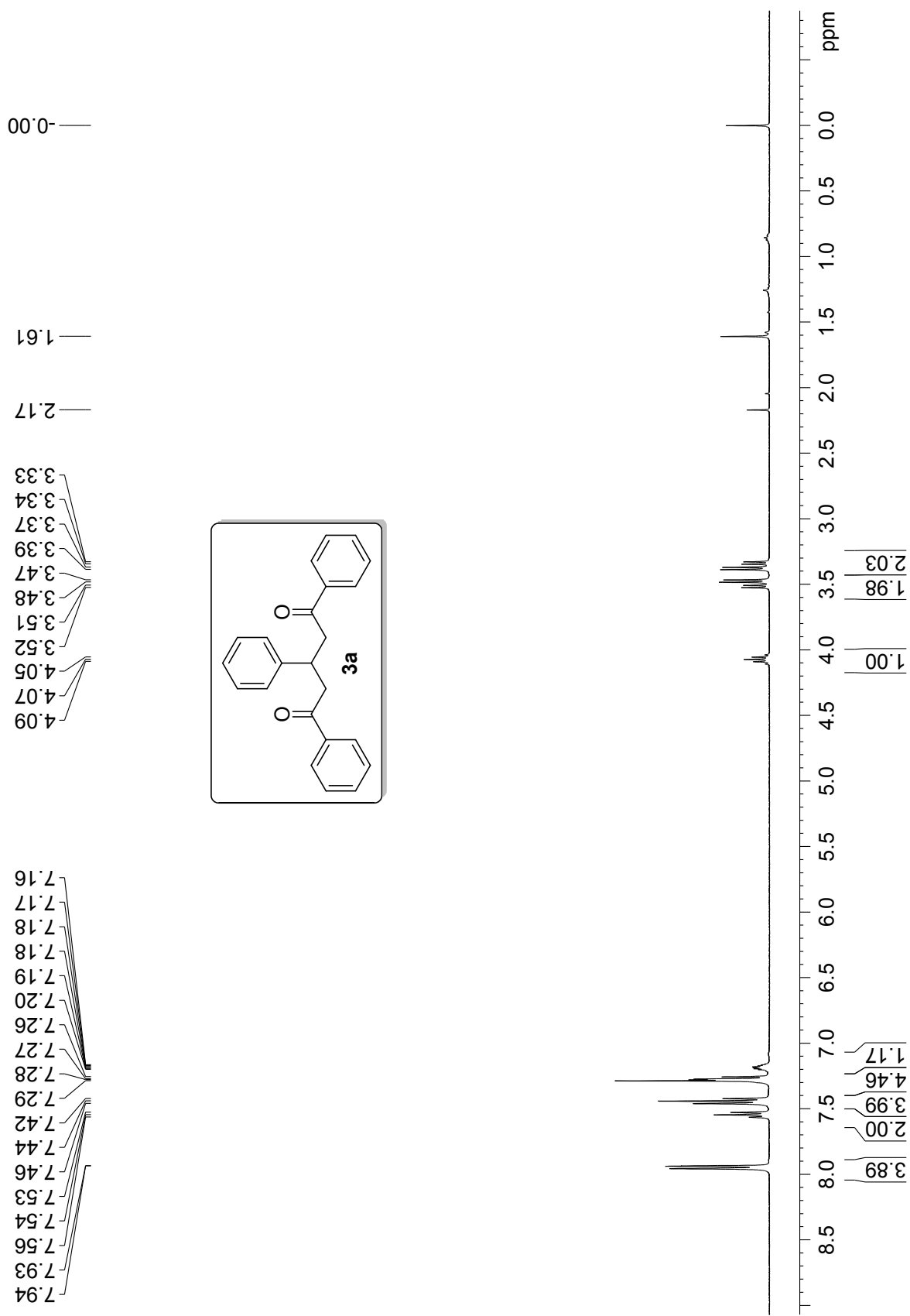

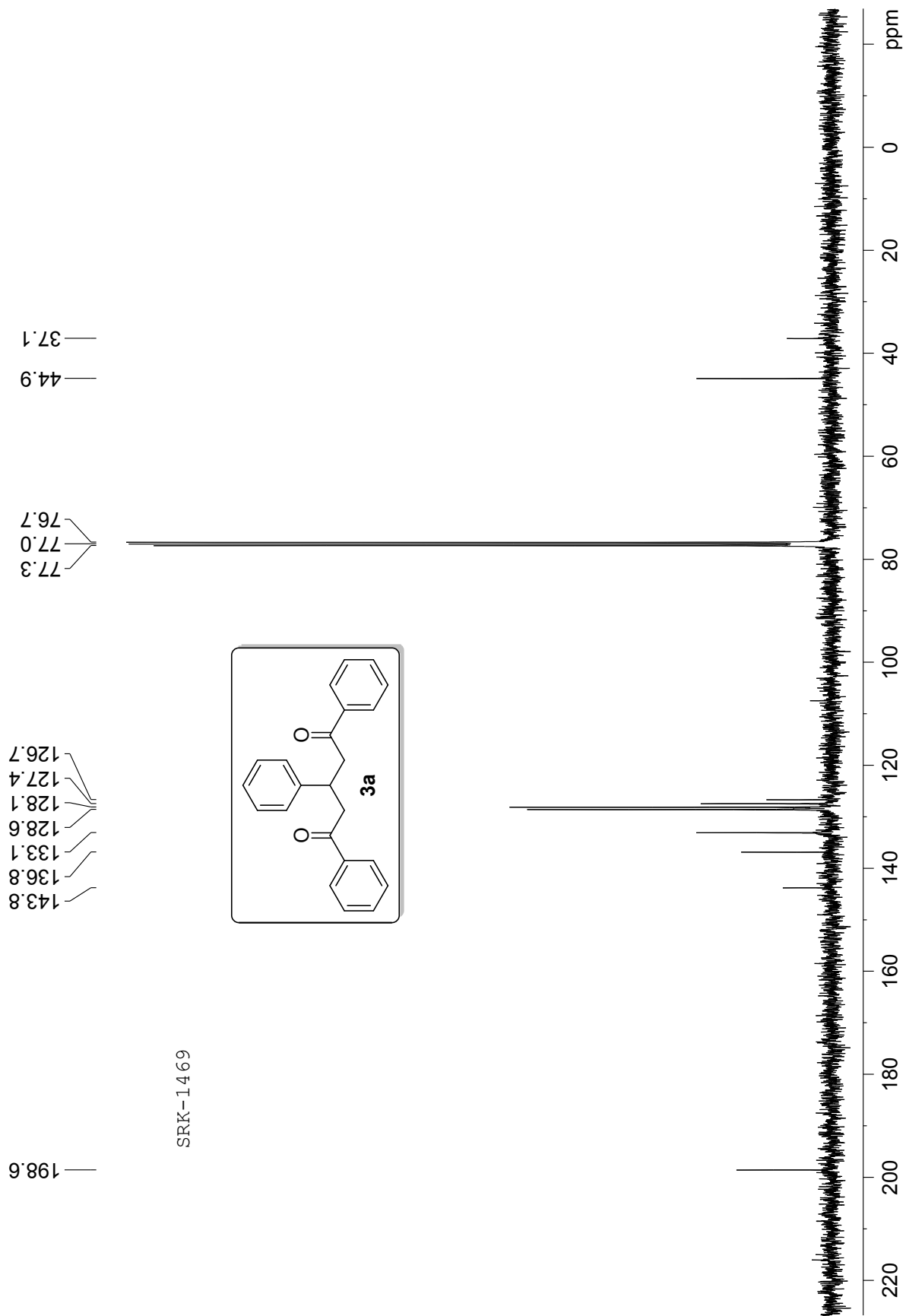

SRK-1469

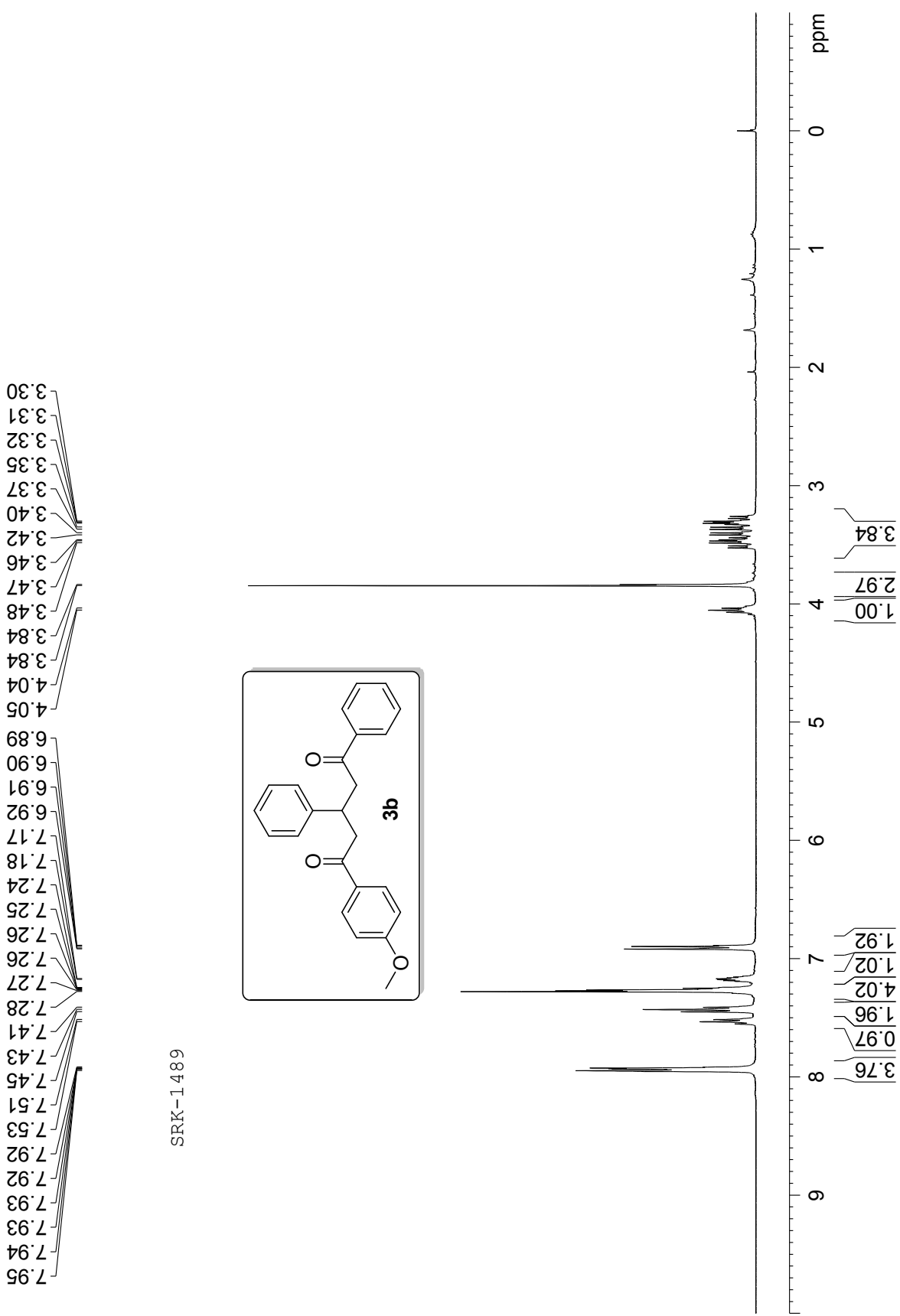

SRK-1489

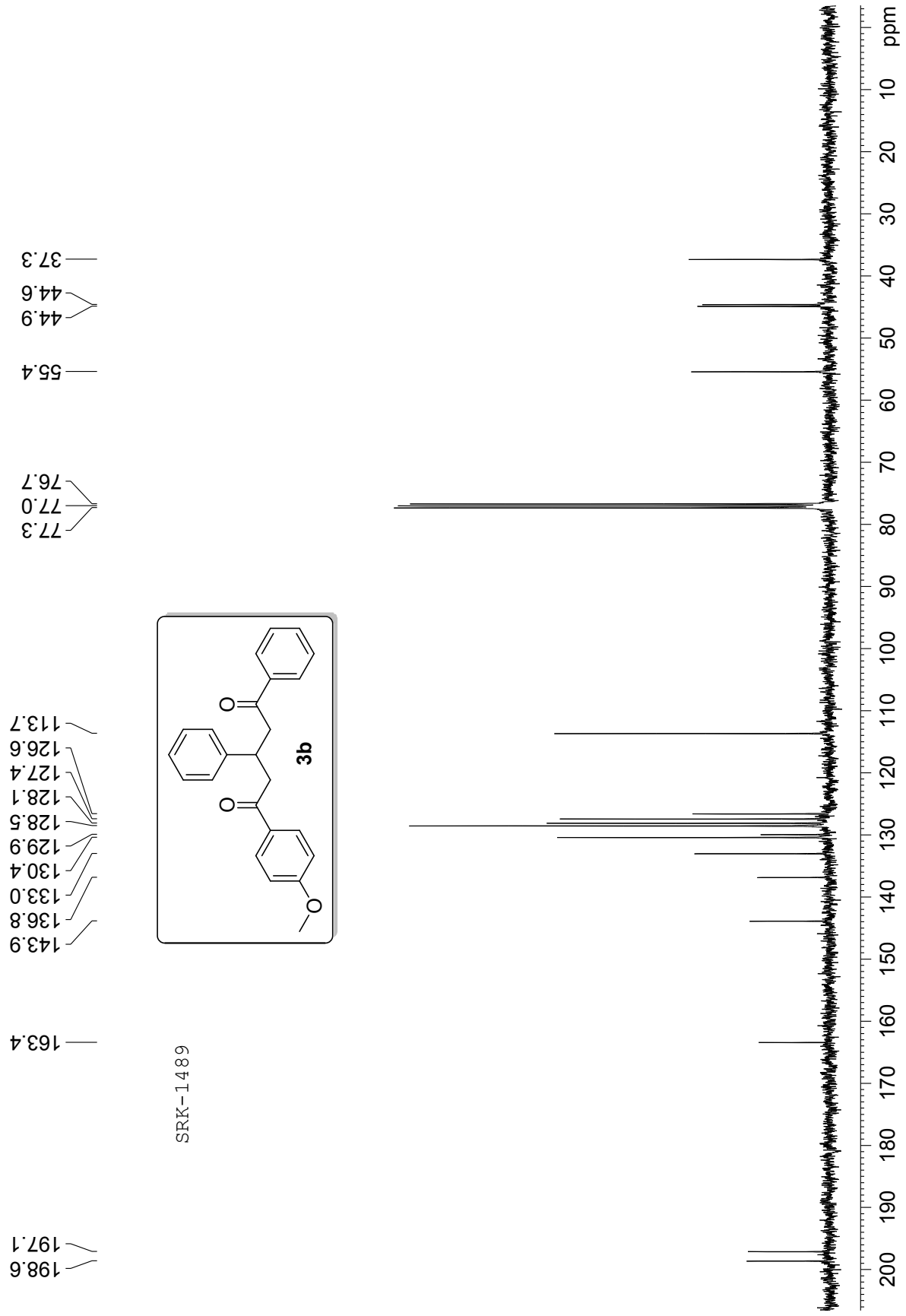

SRK-1489

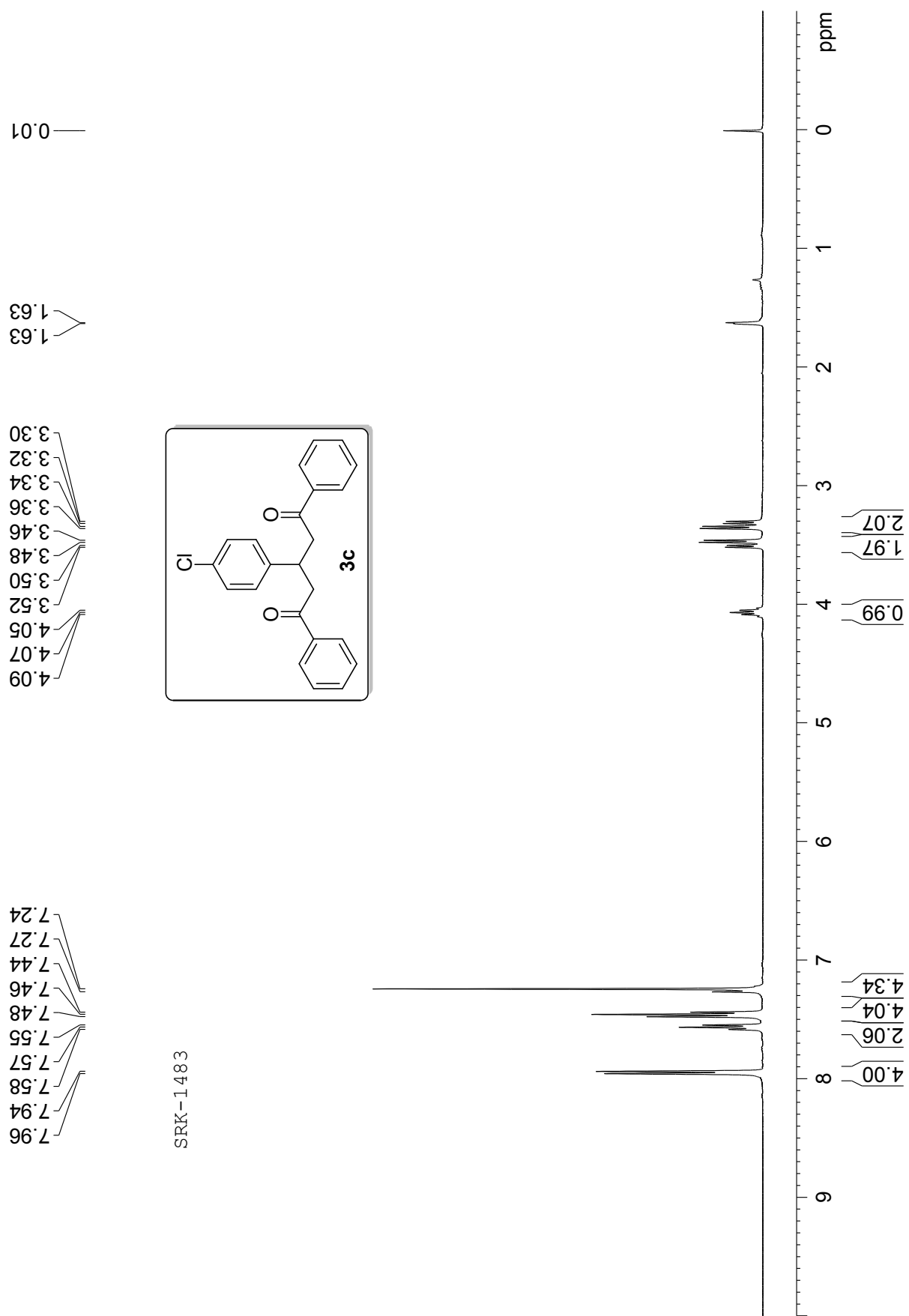

SRK-1483

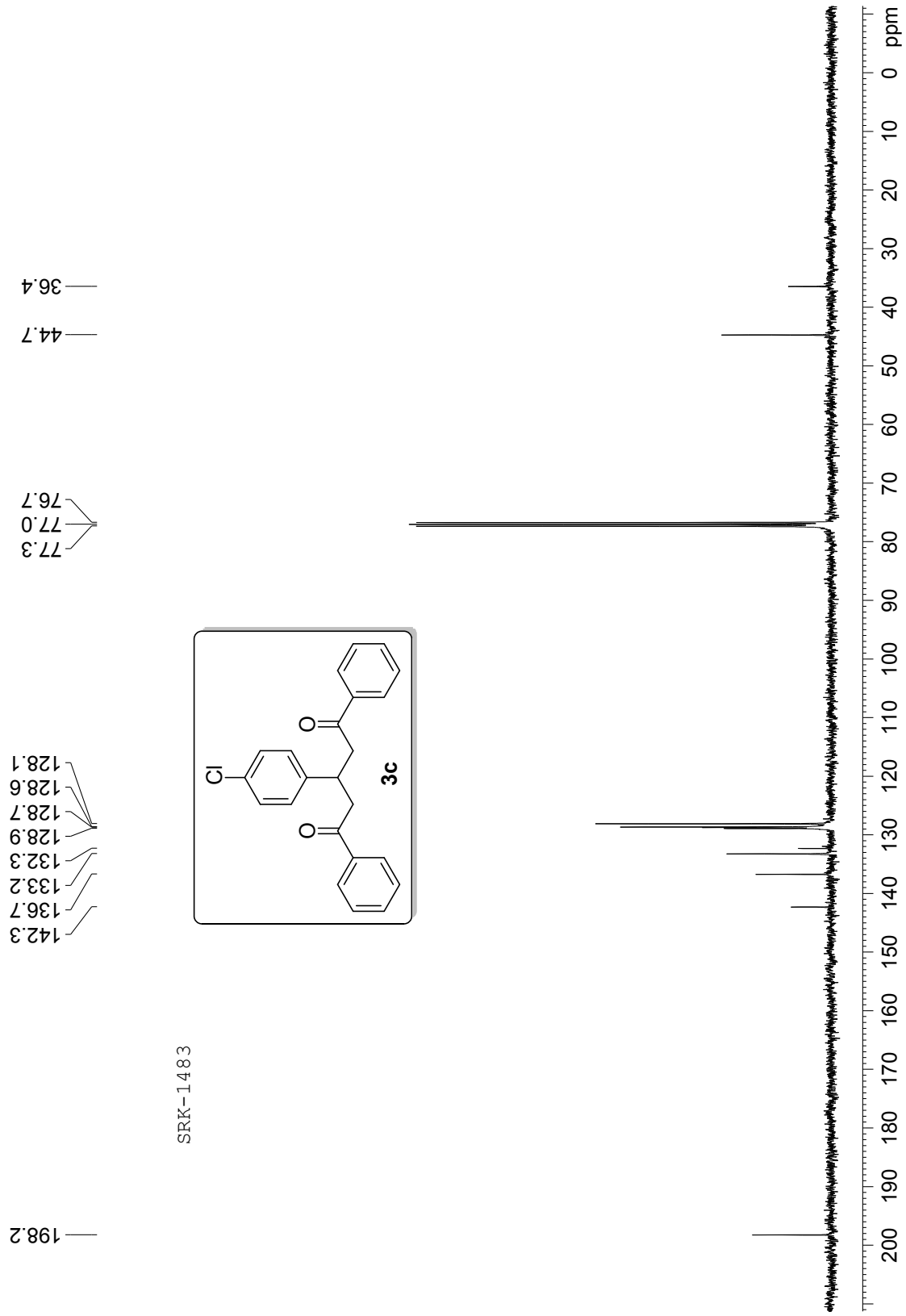

SRK-1483

SpinWorks 3: SRK-1494

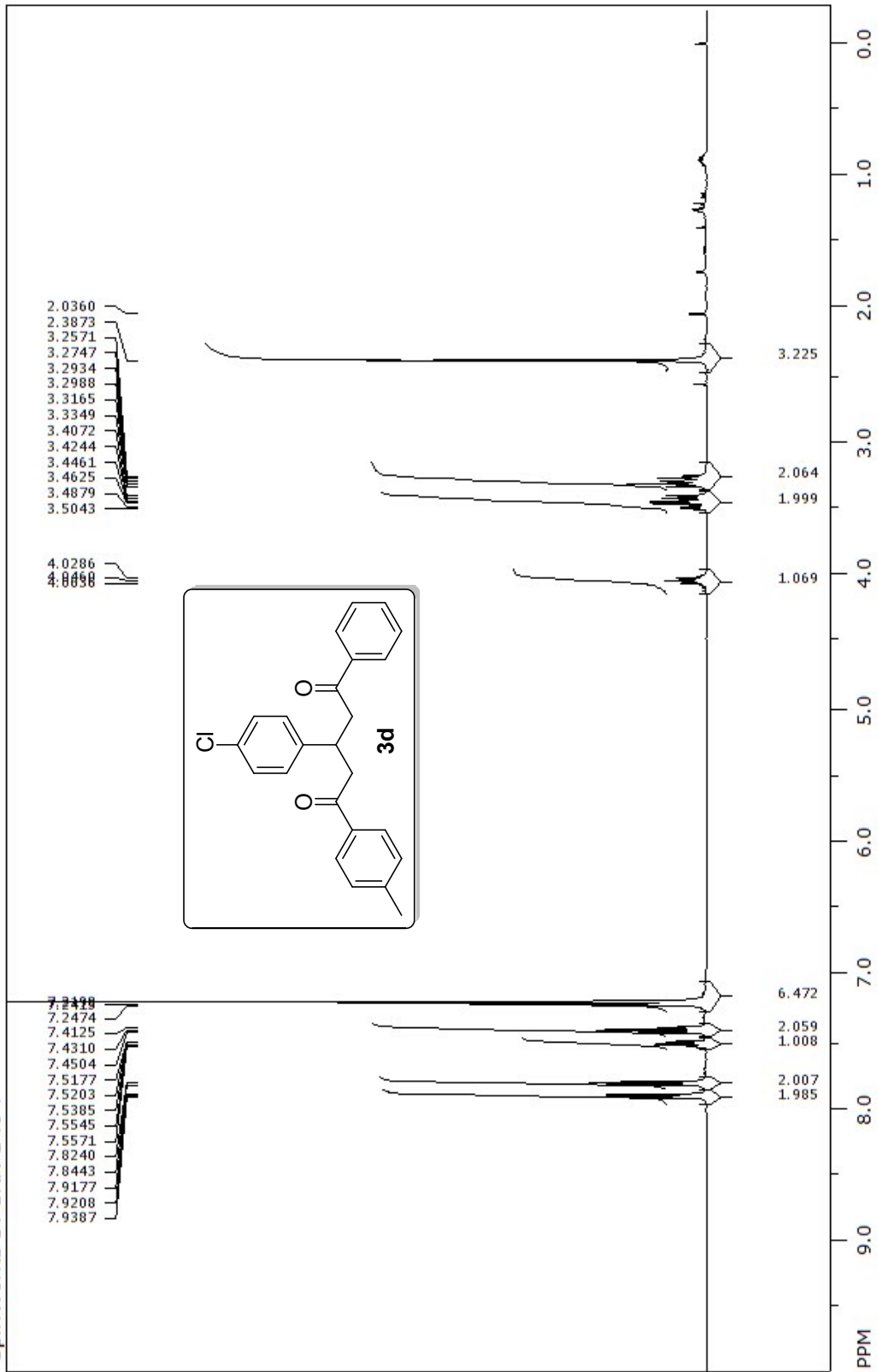



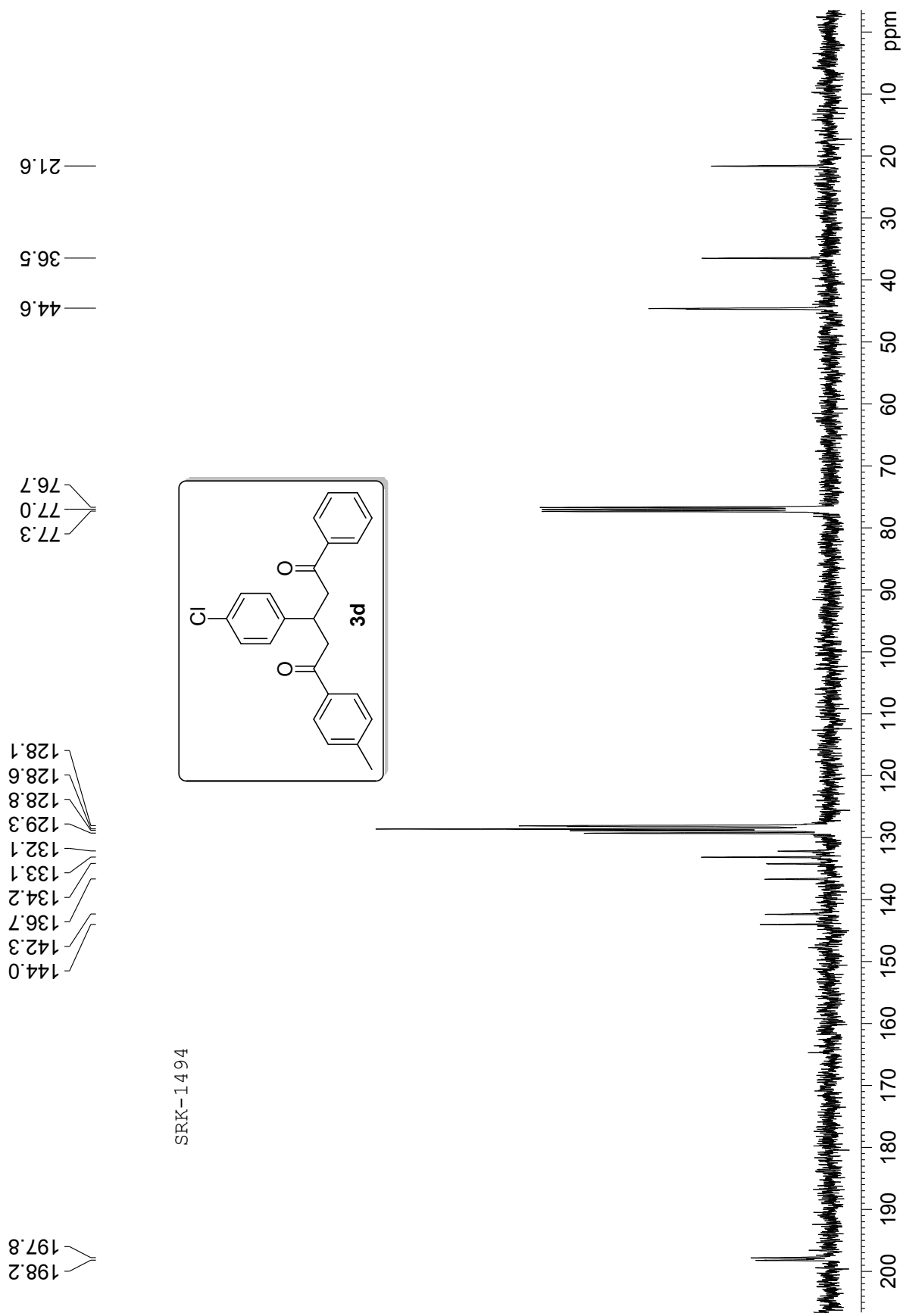

SRK-1494

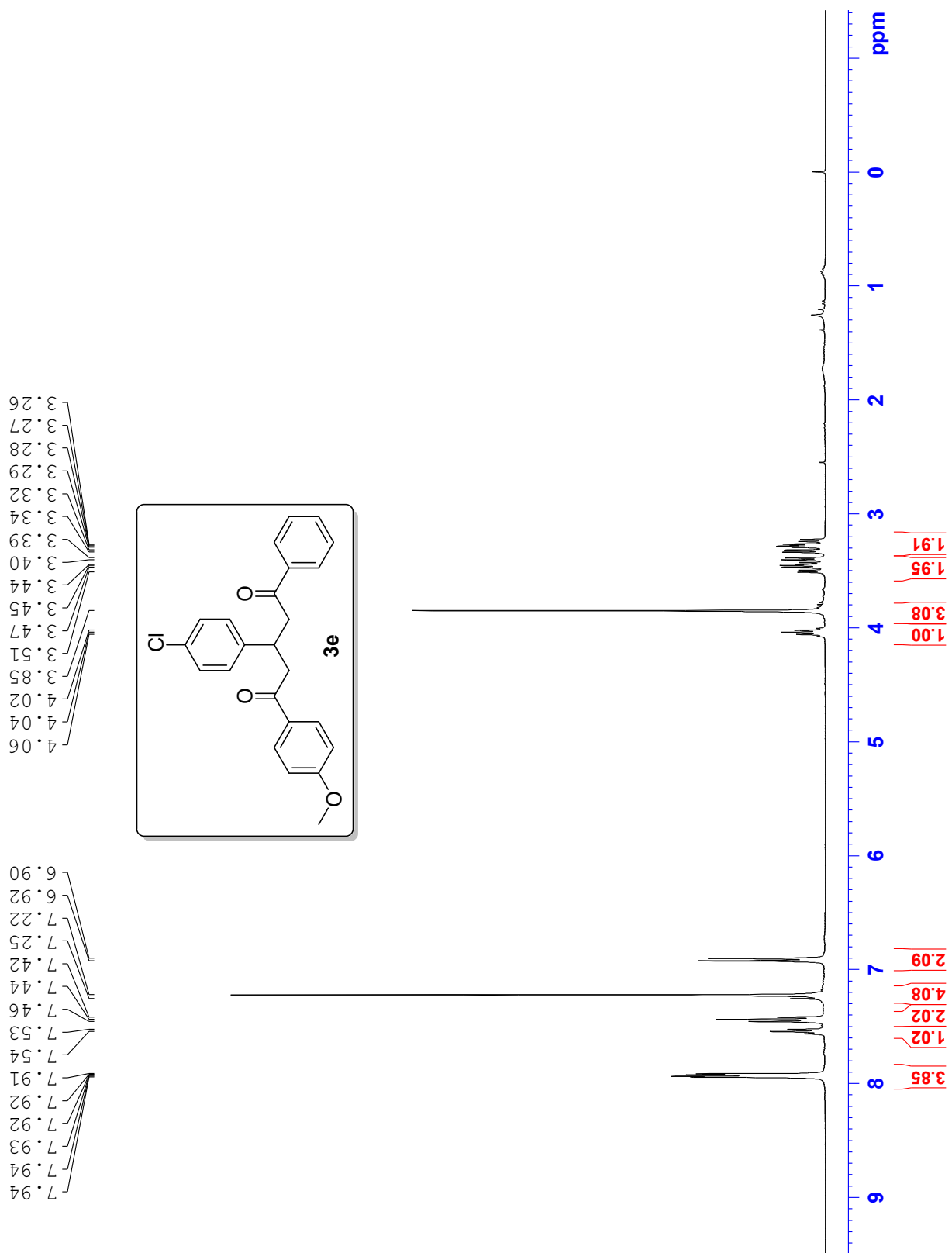

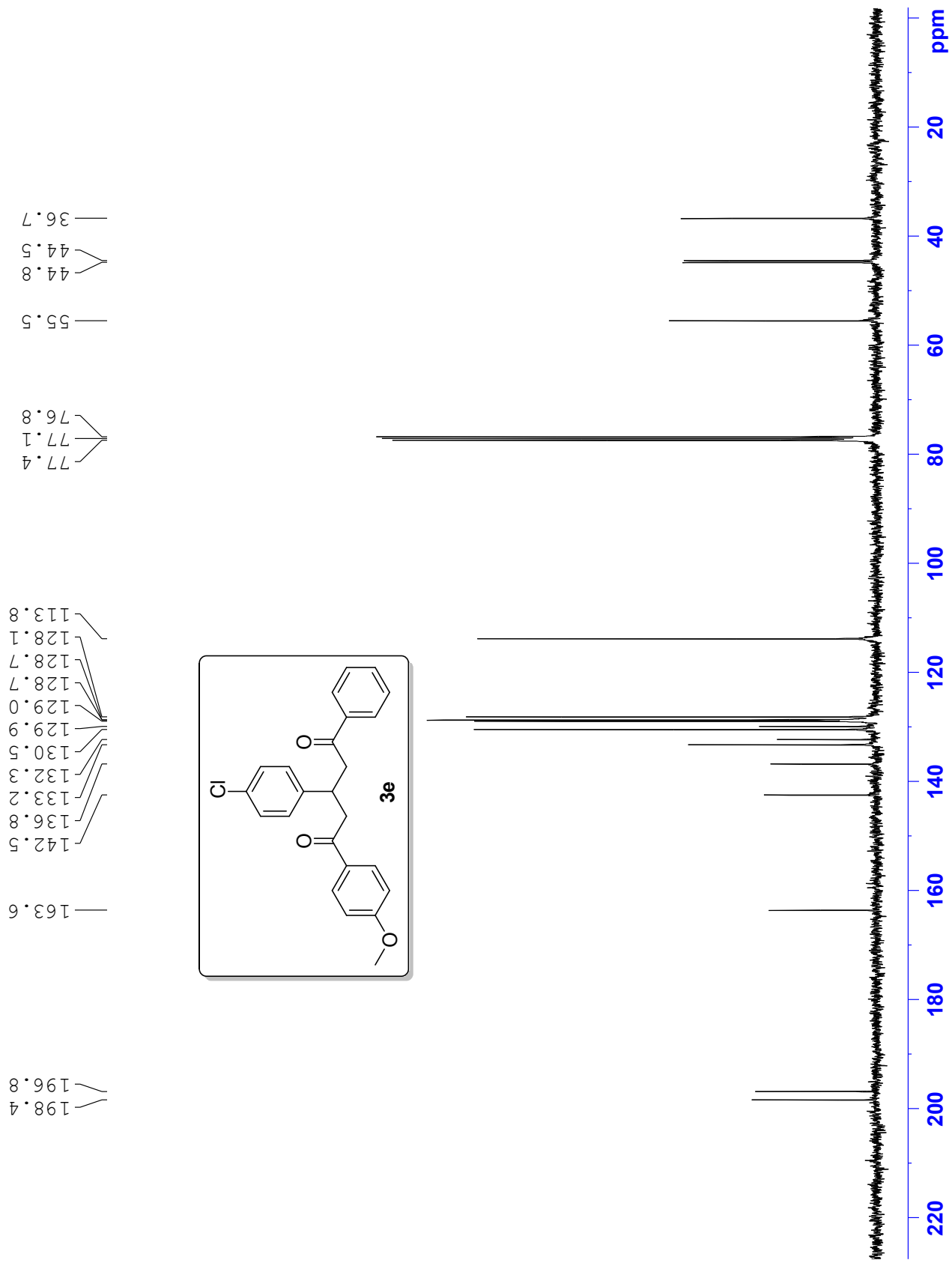

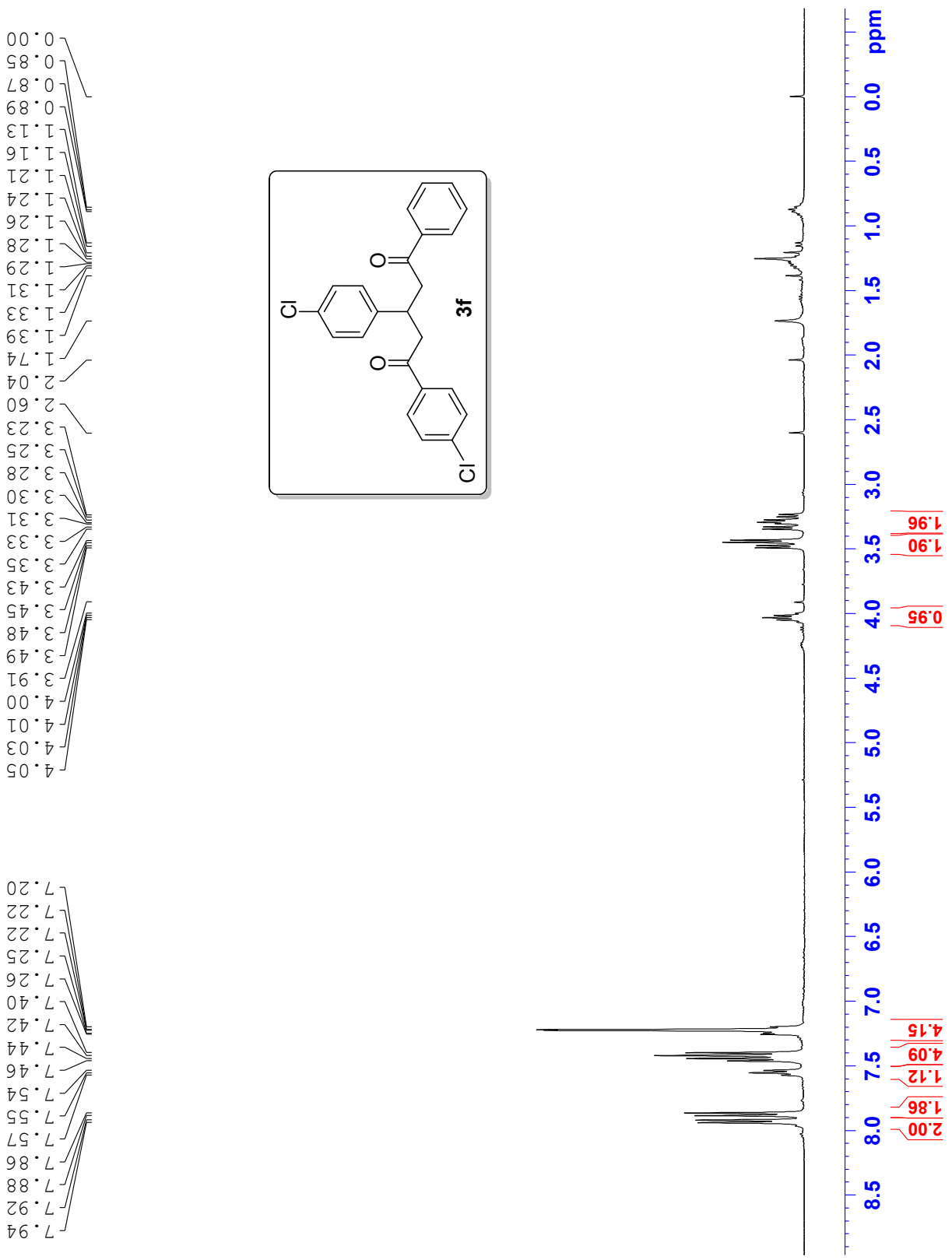

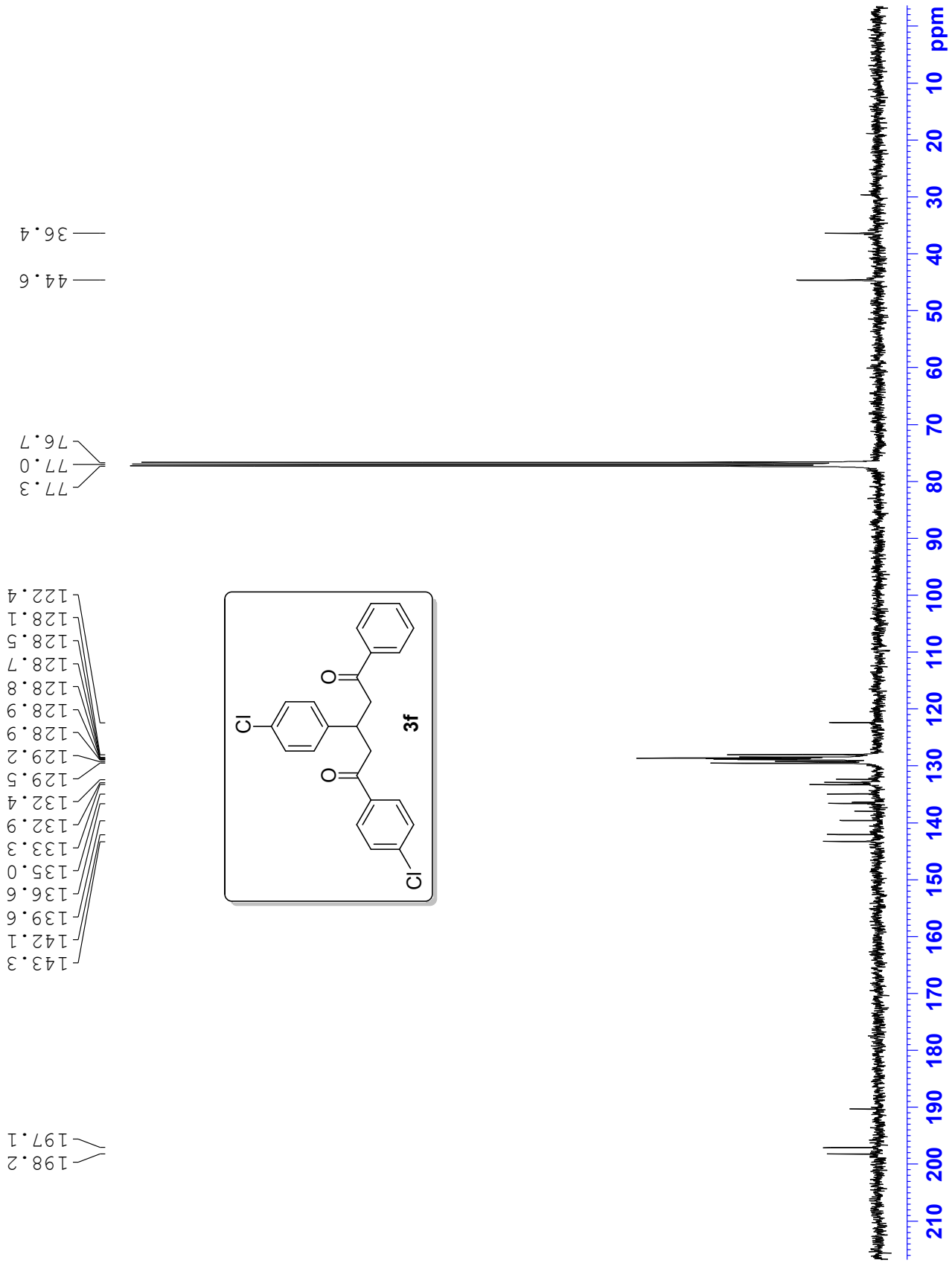



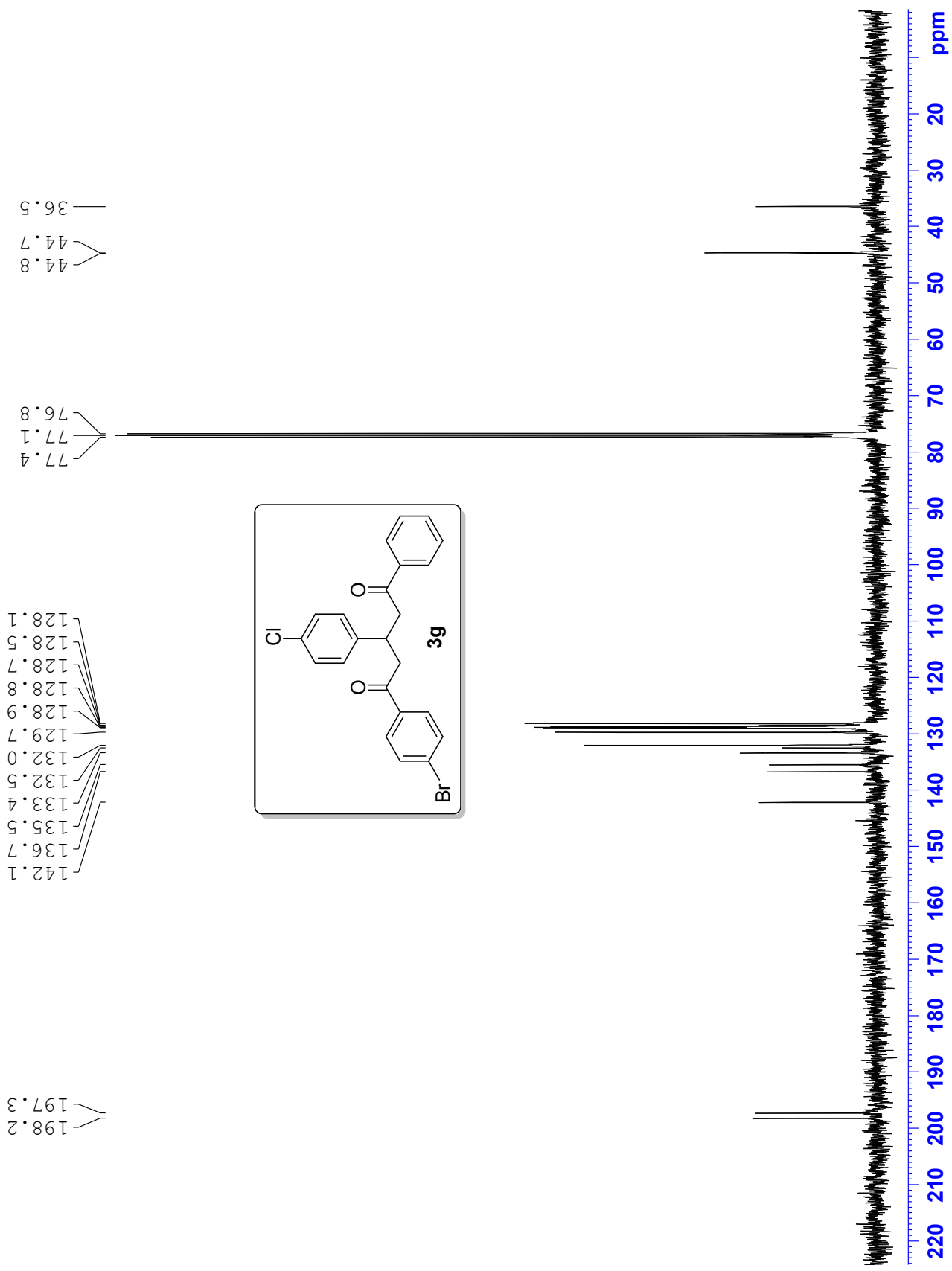

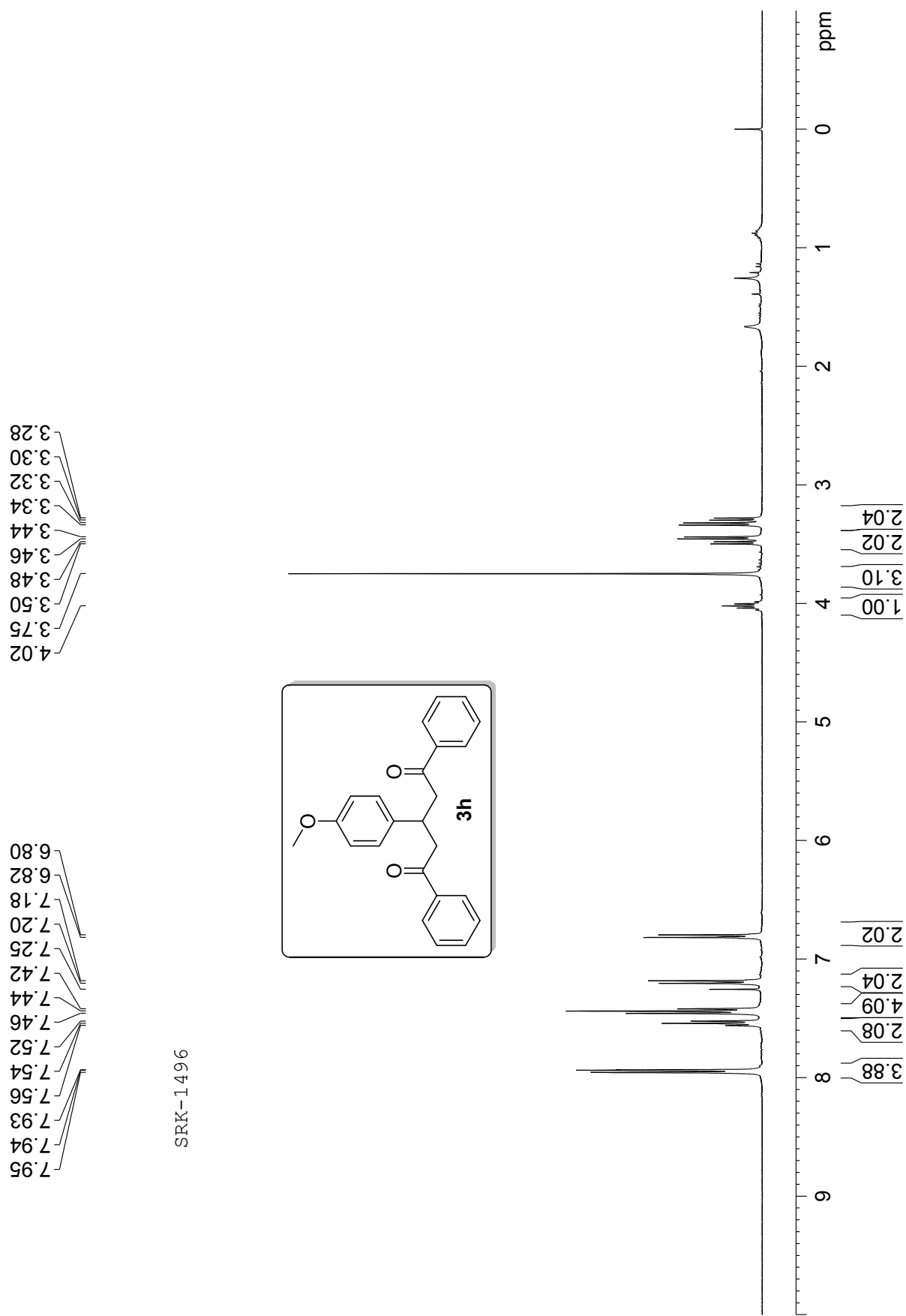

SRK-1496



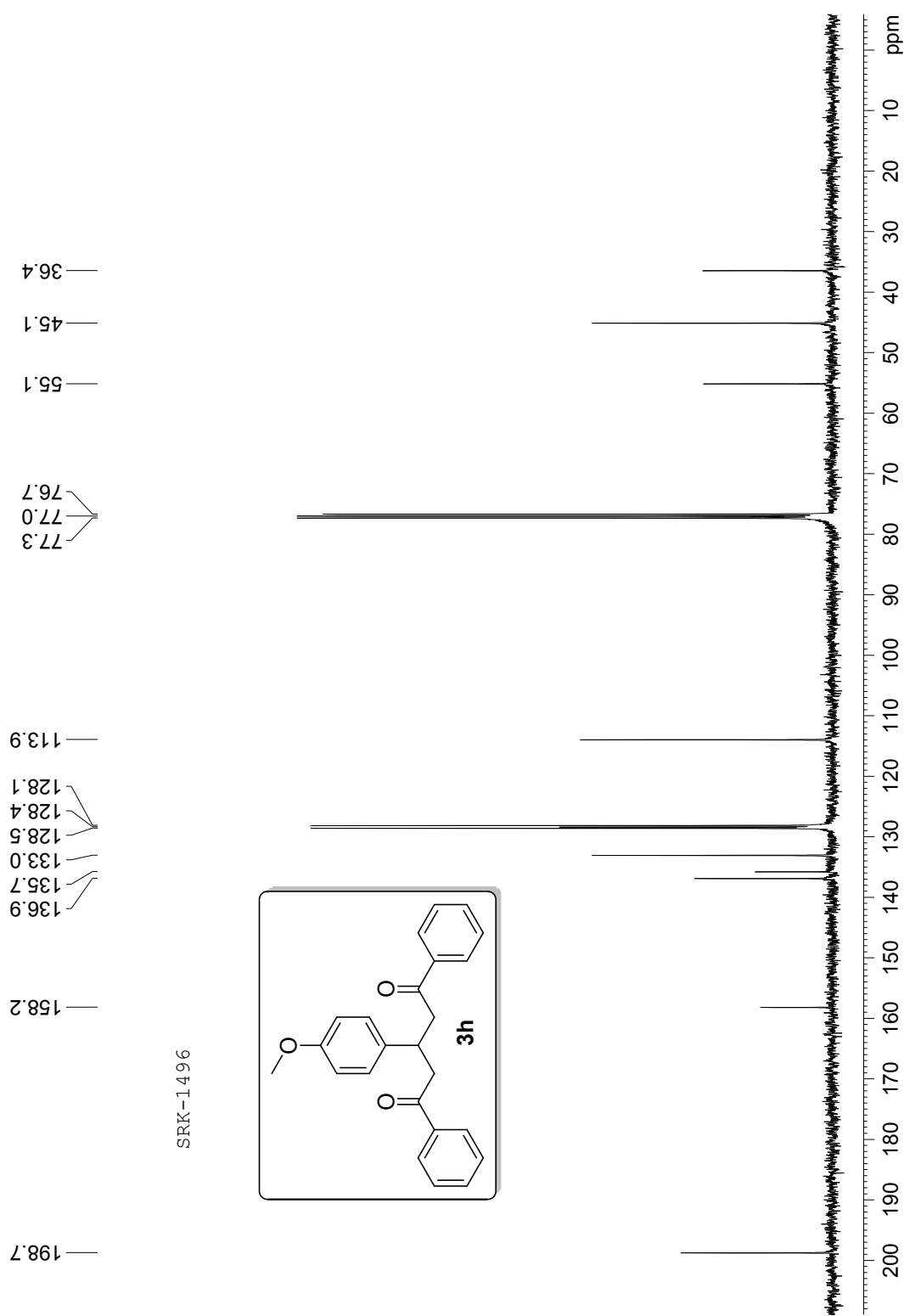

SRK-1496

7.93  
7.86  
7.84  
7.53  
7.51  
7.45  
7.43  
7.41  
7.25  
7.24  
7.22  
7.20  
7.18  
6.81  
6.79

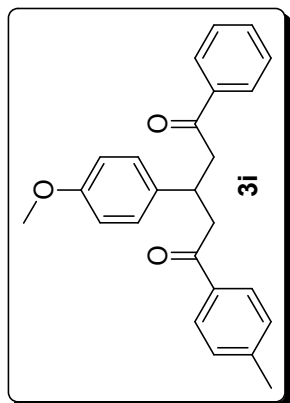

4.01  
3.74  
3.45  
3.44  
3.41  
3.40  
3.32  
3.31  
3.29  
3.27  
2.39  
1.42  
1.29  
1.26

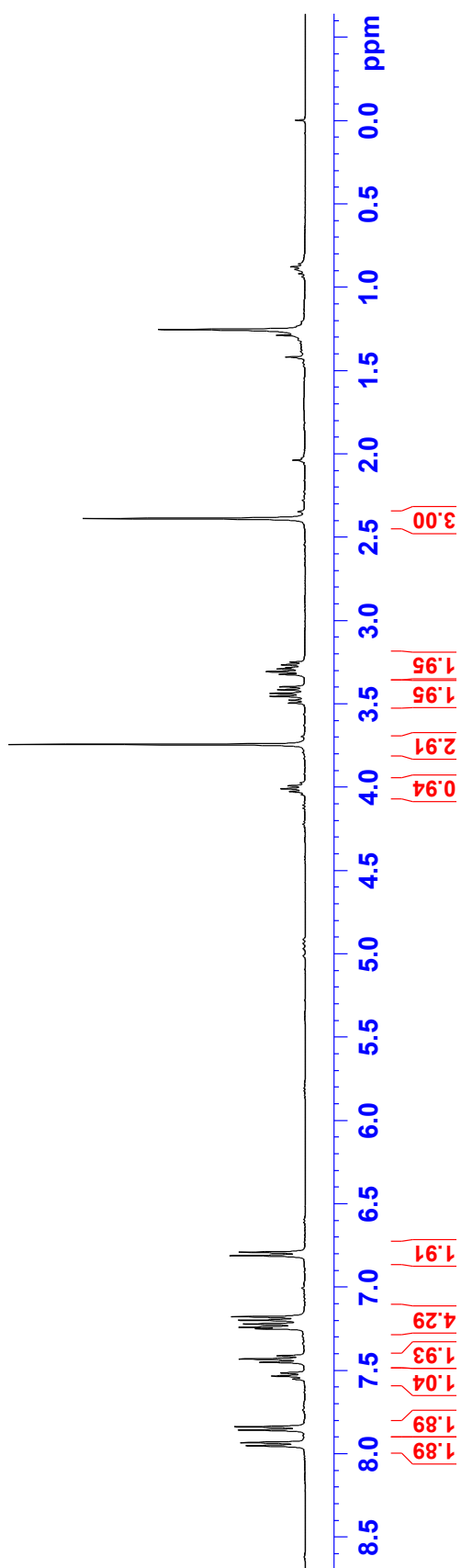

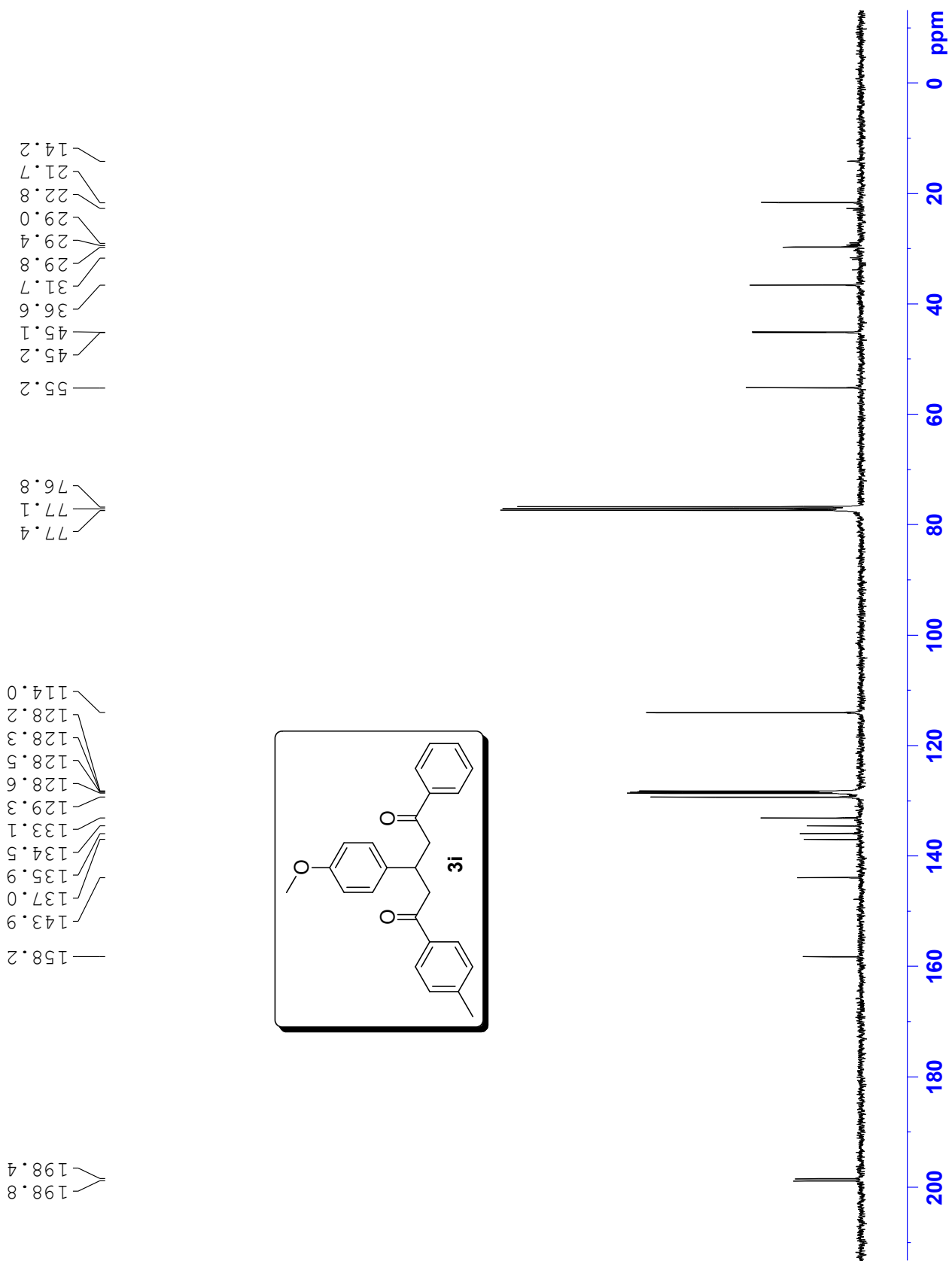

4.00  
 3.84  
 3.83  
 3.74  
 3.46  
 3.44  
 3.39  
 3.37  
 3.32  
 3.30  
 3.27  
 3.25

7.95  
 7.93  
 7.93  
 7.93  
 7.93  
 7.53  
 7.53  
 7.51  
 7.45  
 7.43  
 7.41  
 7.25  
 7.20  
 7.18  
 6.92  
 6.92  
 6.90  
 6.81  
 6.79

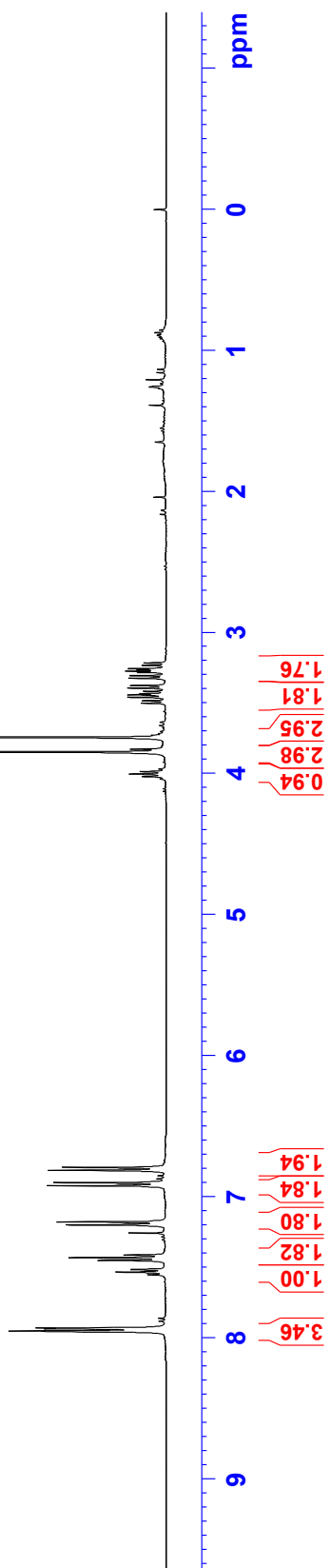
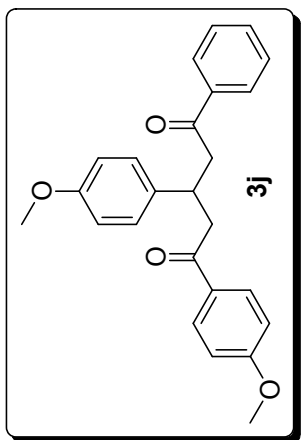

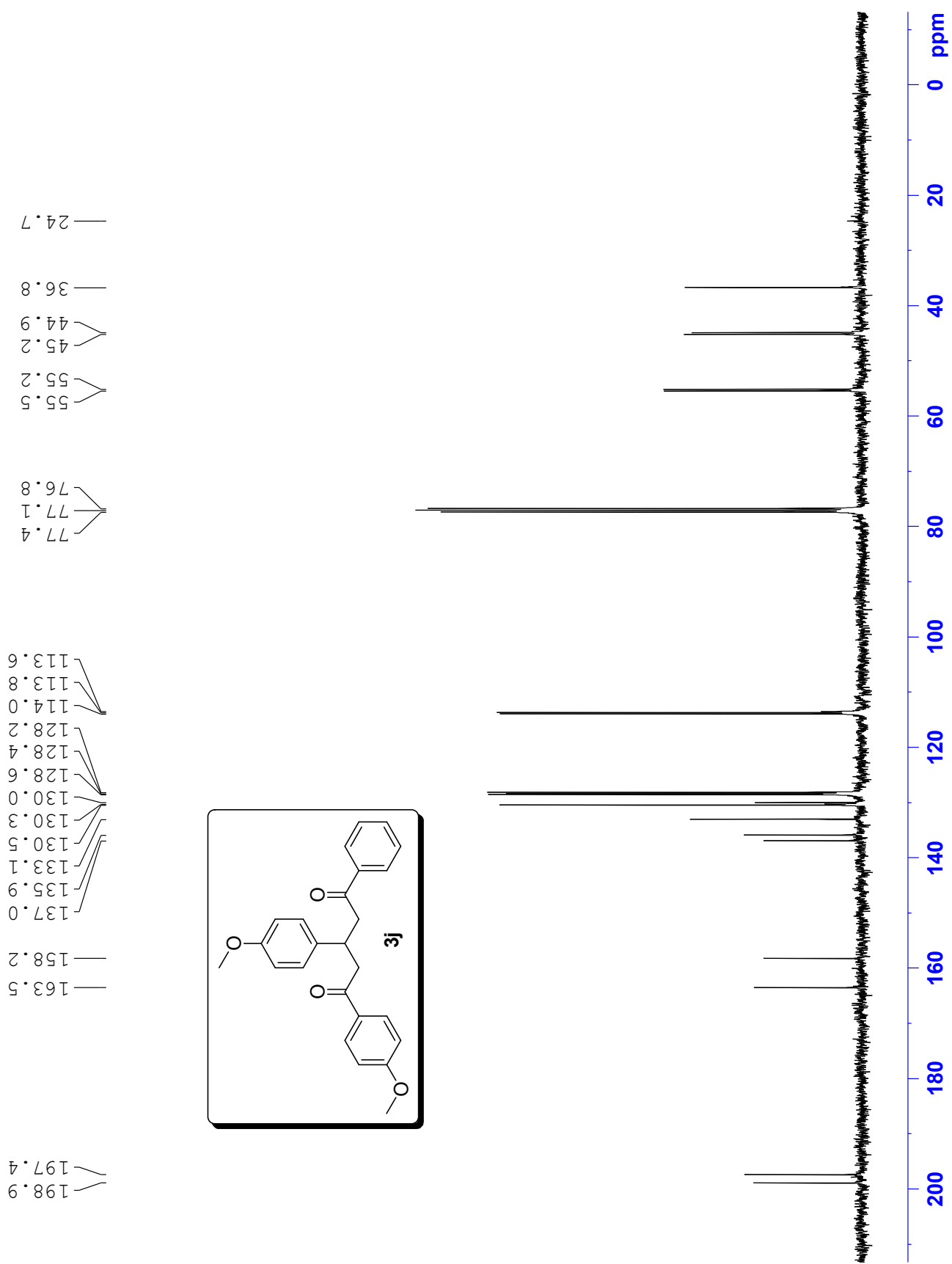

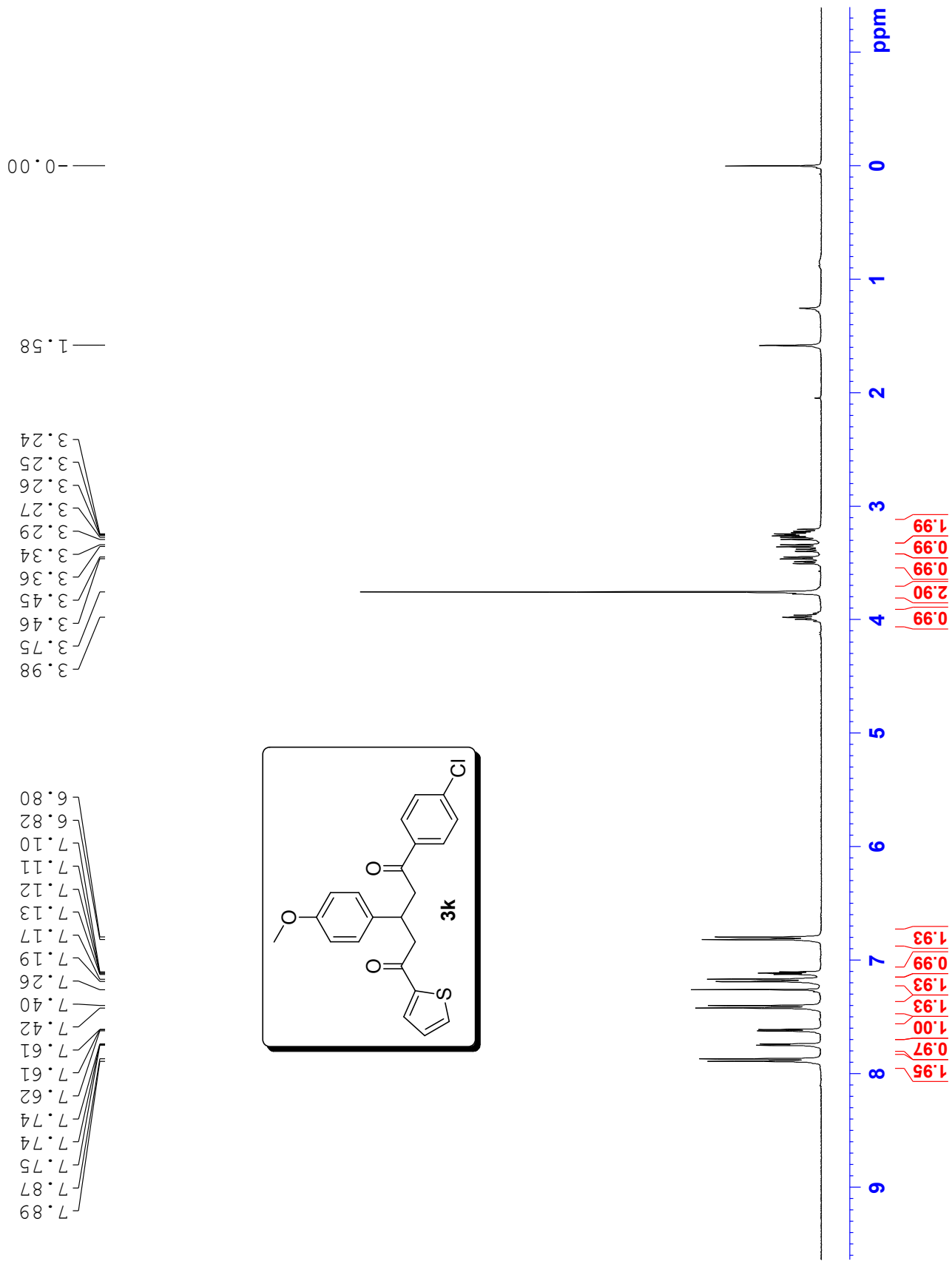

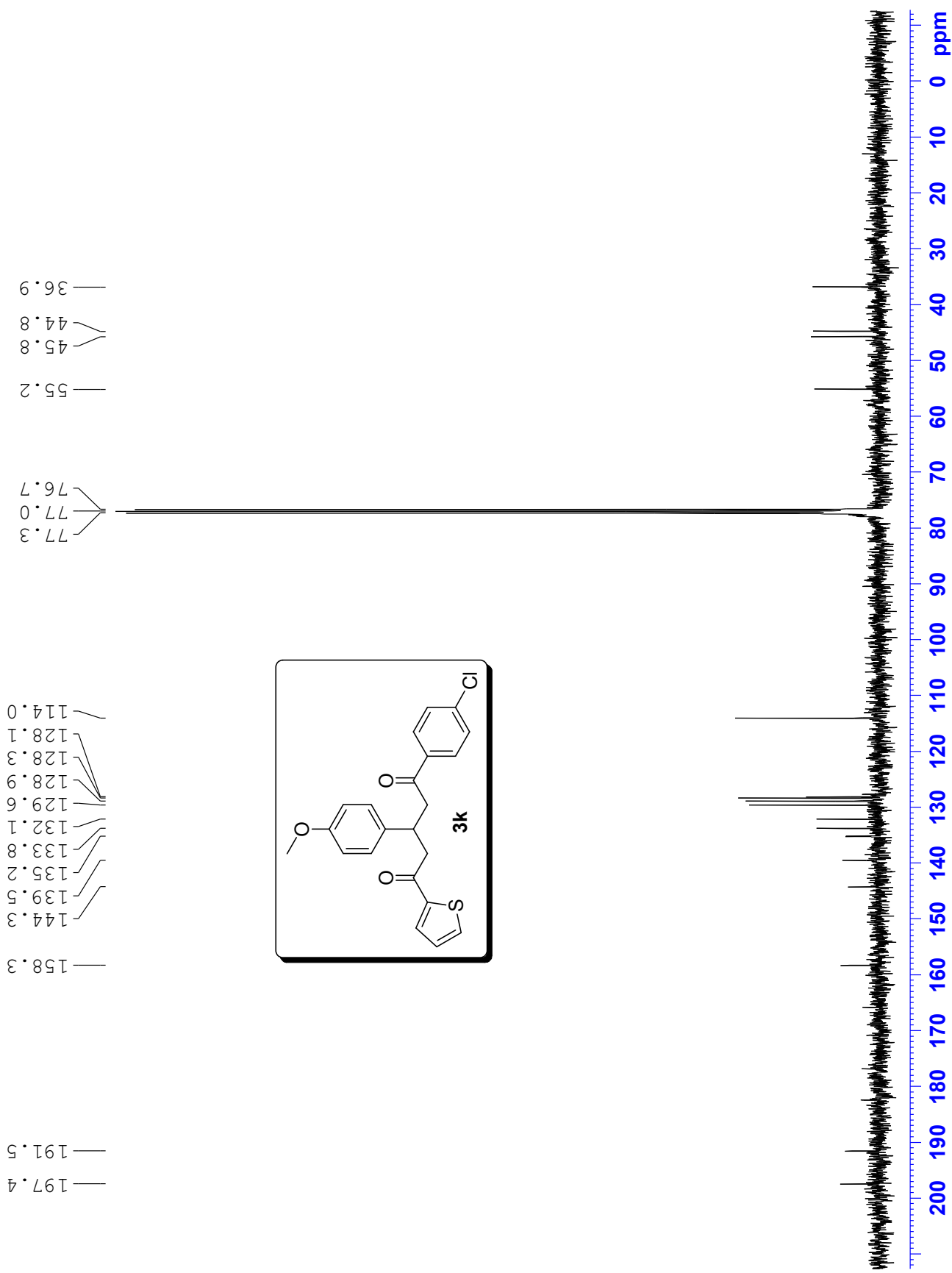

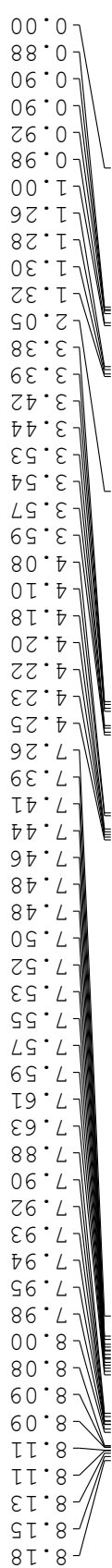

SRK-1623

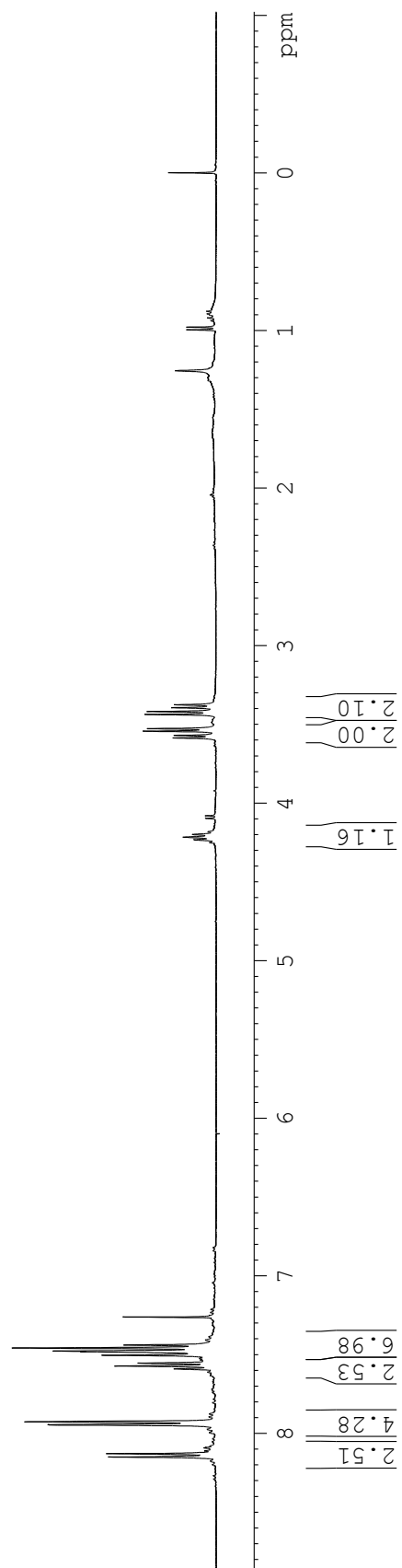
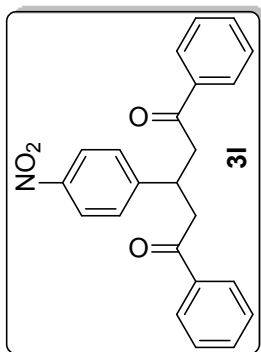



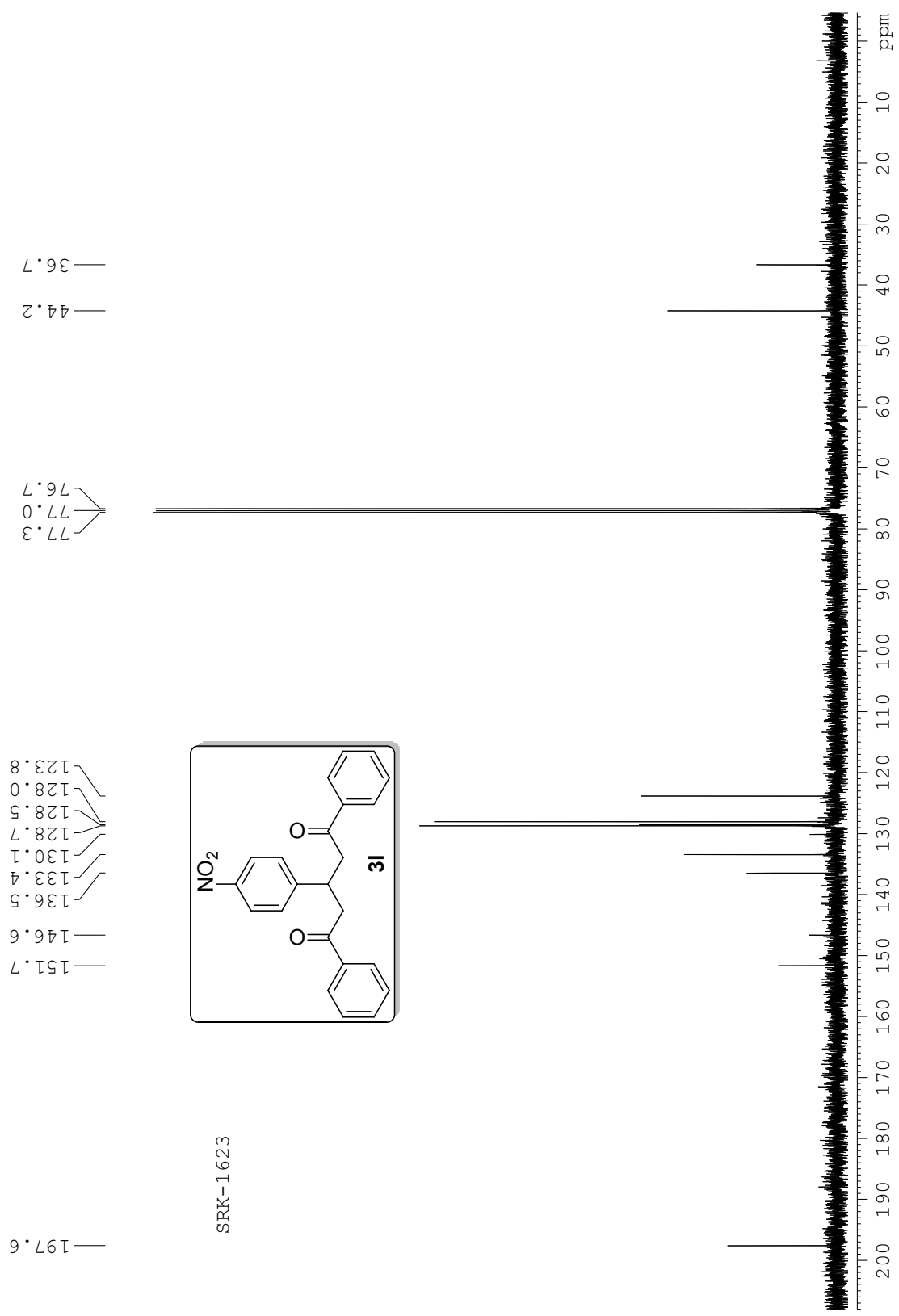

SRK-1623

0.00  
 0.85  
 0.86  
 0.86  
 0.87  
 0.88  
 0.88  
 0.90  
 0.97  
 0.98  
 1.00  
 1.26  
 1.28  
 1.42  
 1.66  
 3.31  
 3.33  
 3.36  
 3.37  
 3.37  
 3.39  
 3.41  
 3.43  
 3.50  
 3.51  
 3.51  
 3.52  
 3.54  
 3.55  
 3.55  
 3.57  
 4.08  
 4.09  
 4.15  
 4.17  
 4.19  
 4.20  
 4.22  
 7.26  
 7.44  
 7.46  
 7.47  
 7.48  
 7.49  
 7.56  
 7.56  
 7.57  
 7.59  
 7.60  
 7.63  
 7.65  
 7.65  
 7.81  
 7.83  
 7.92  
 7.92  
 7.94  
 7.94  
 8.12  
 8.14

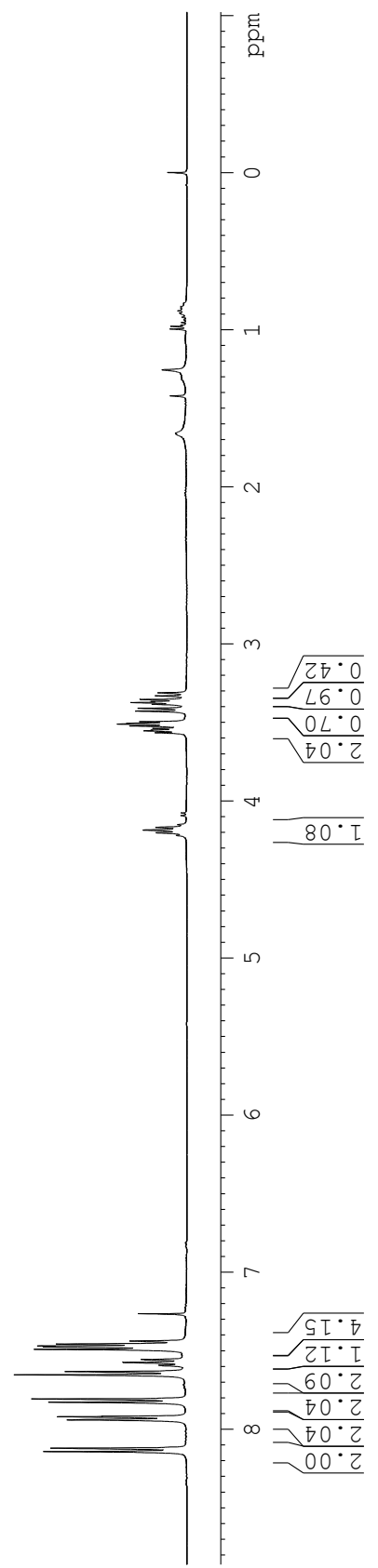
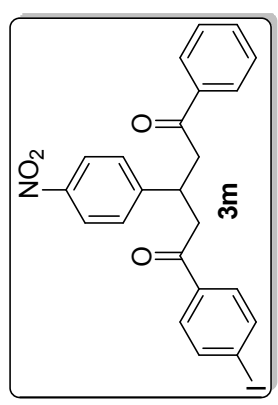

SRK-1624

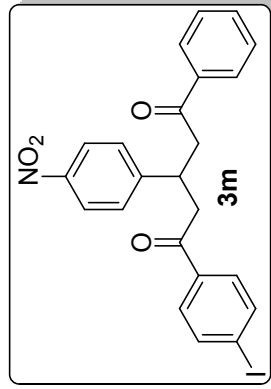

- 197.5
- 196.9
- 151.4
- 146.6
- 138.0
- 136.4
- 135.6
- 133.5
- 129.4
- 128.7
- 128.5
- 128.0
- 123.8
- 101.5
- 77.3
- 77.0
- 76.7
- 44.1
- 44.0
- 36.5

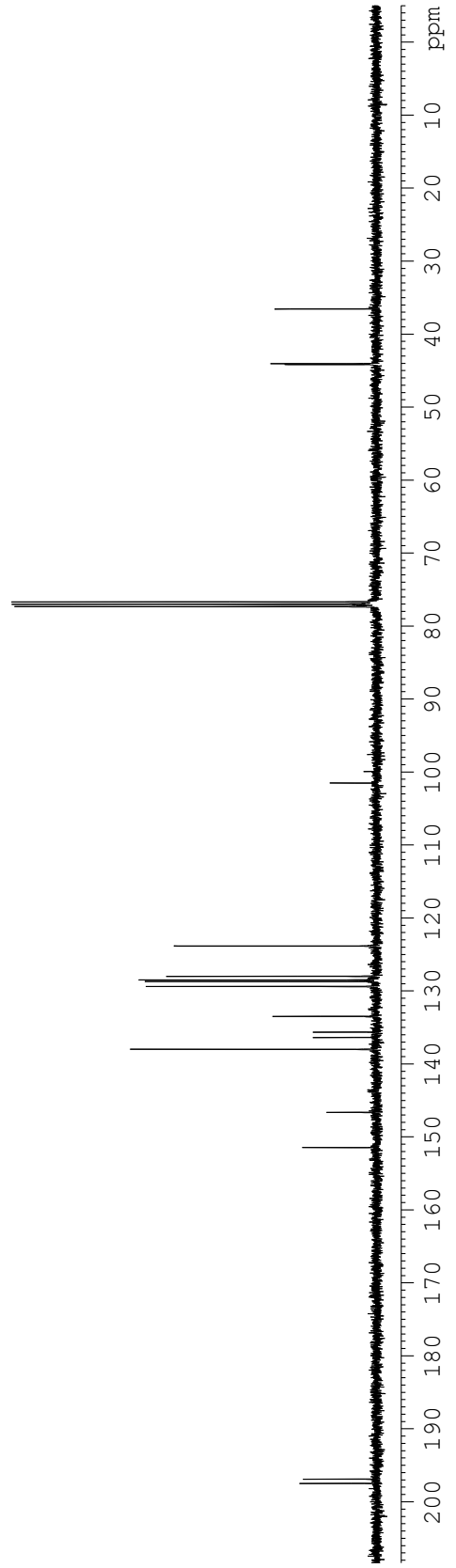

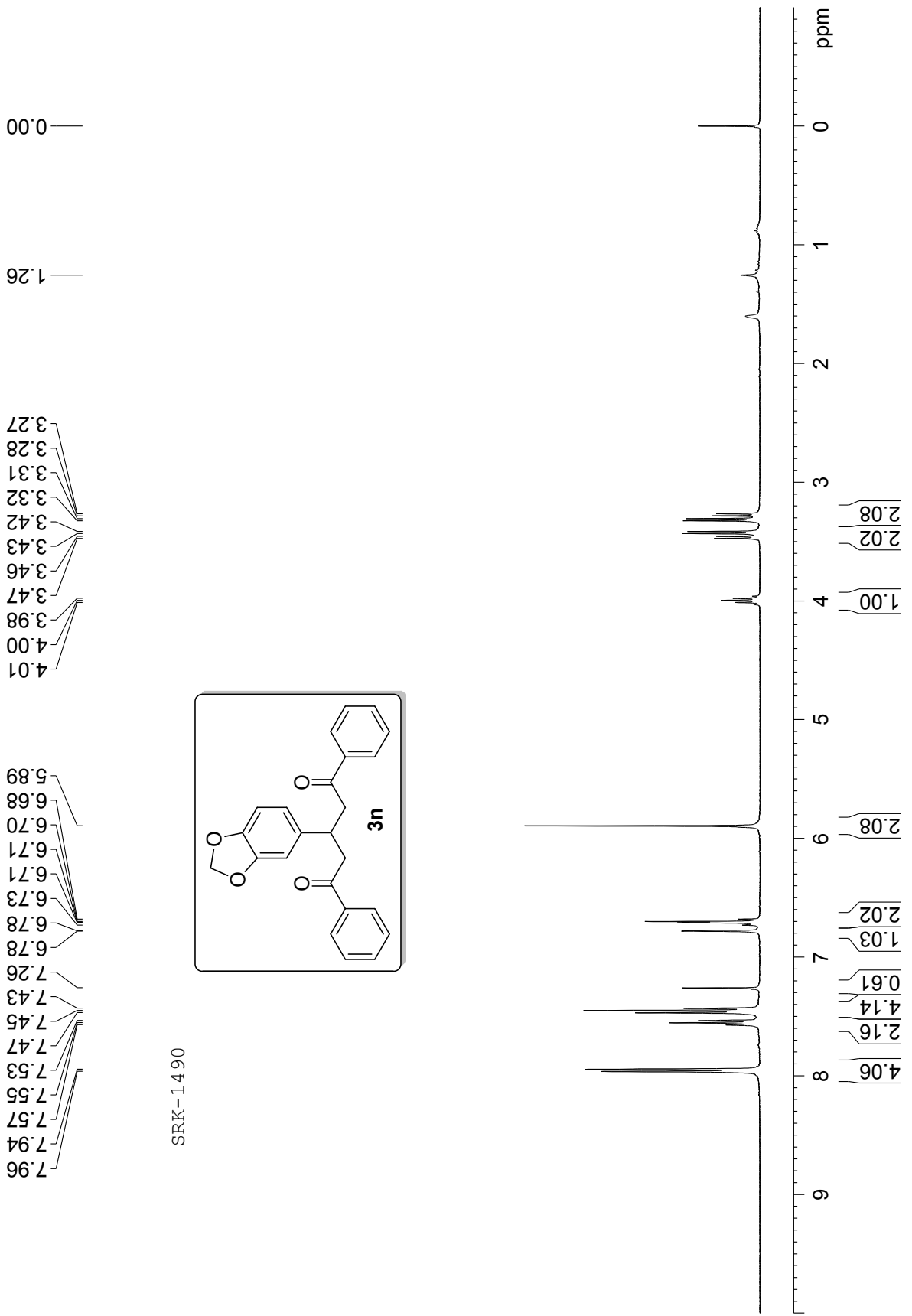

SRK-1490

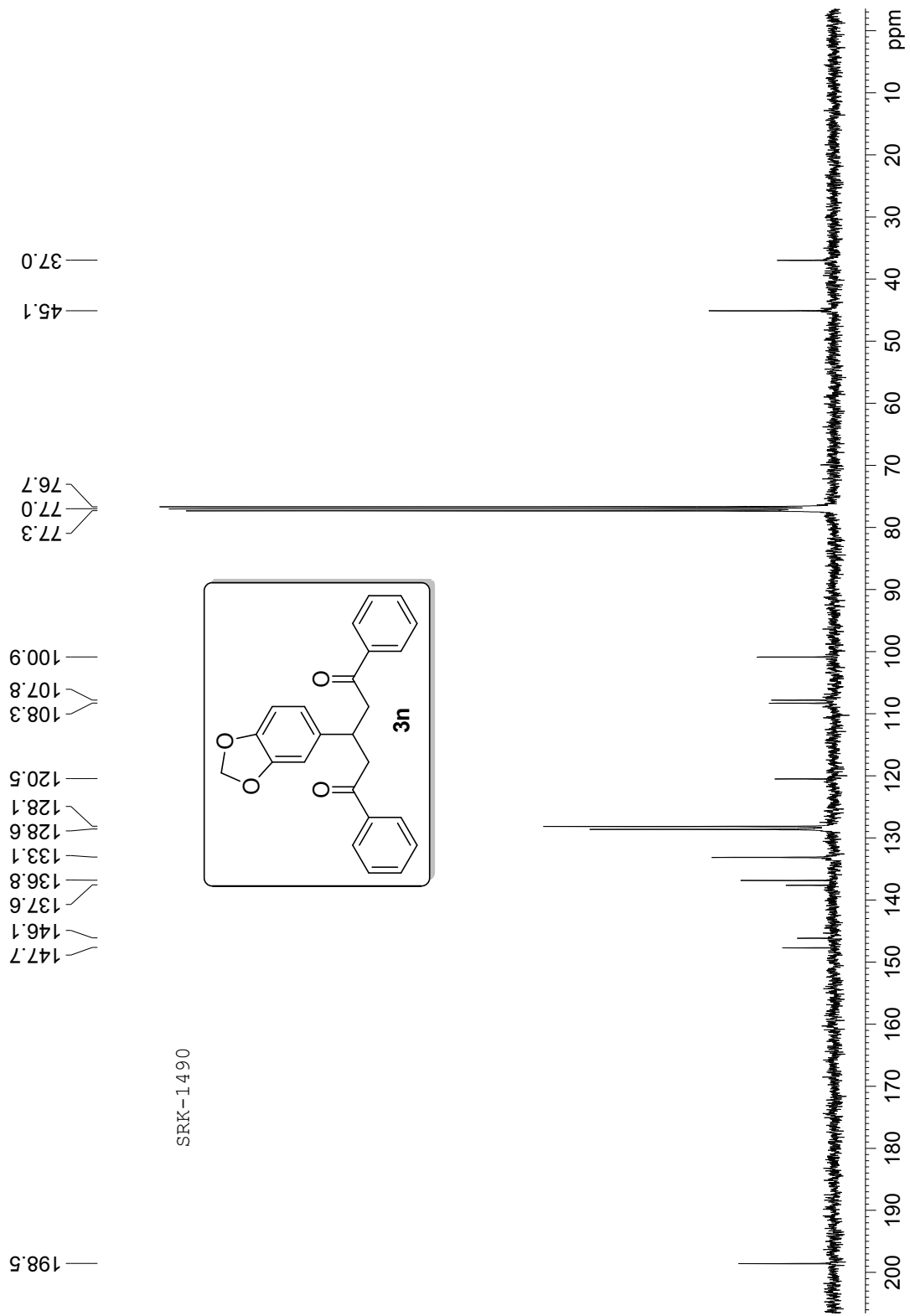

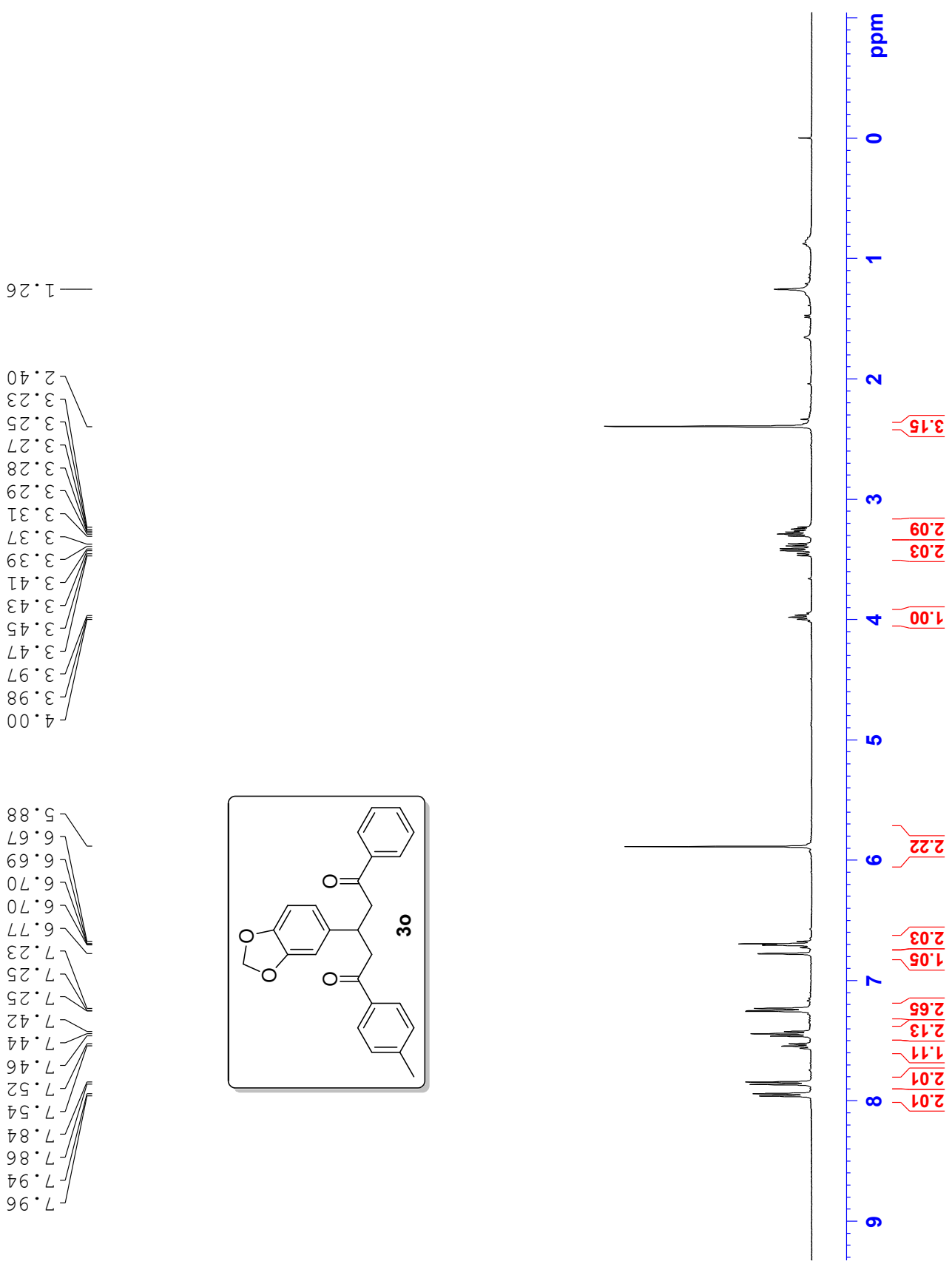

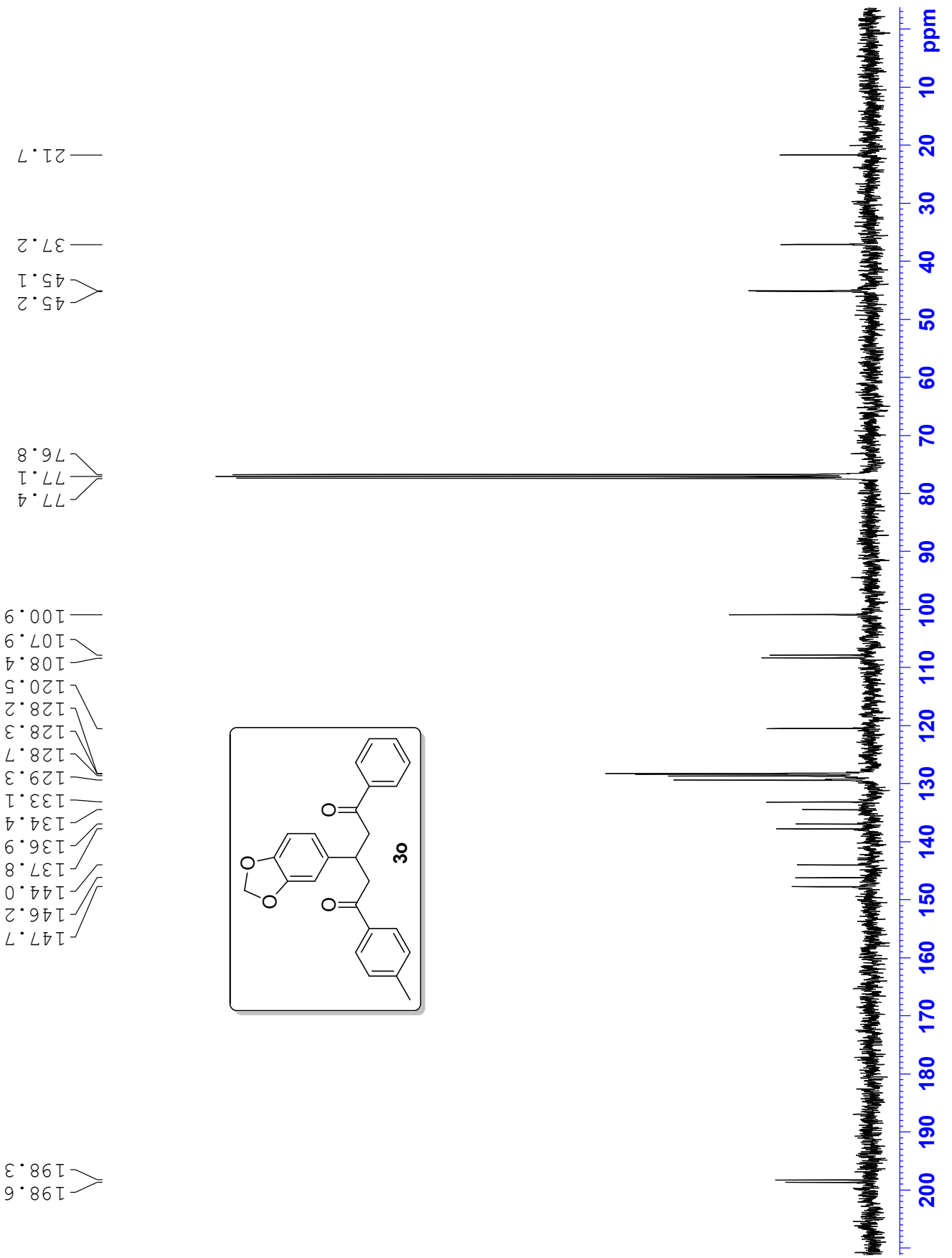

SpinWorks 3: SRK-1541

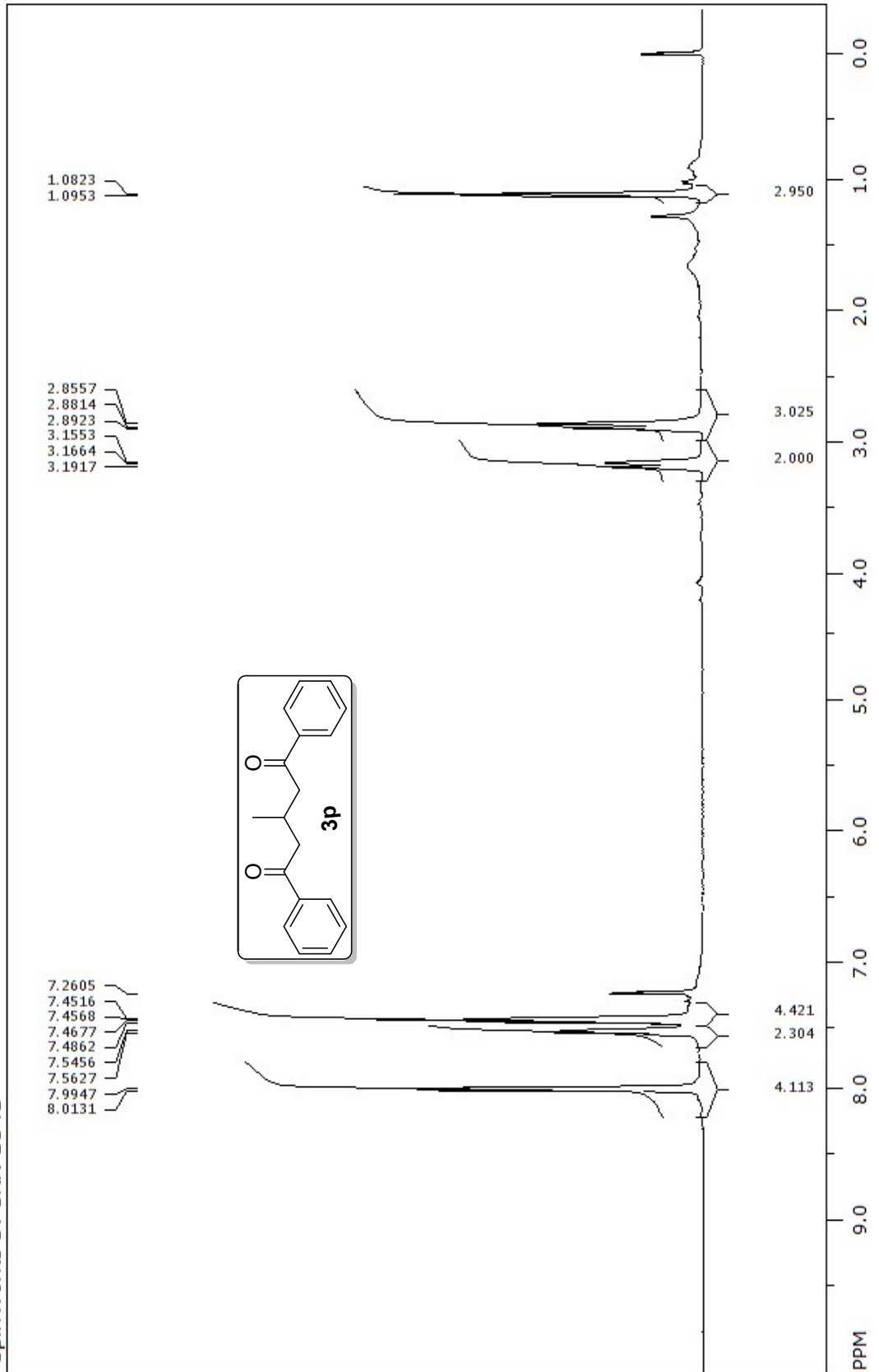



SpinWorks 3: SRK-1541

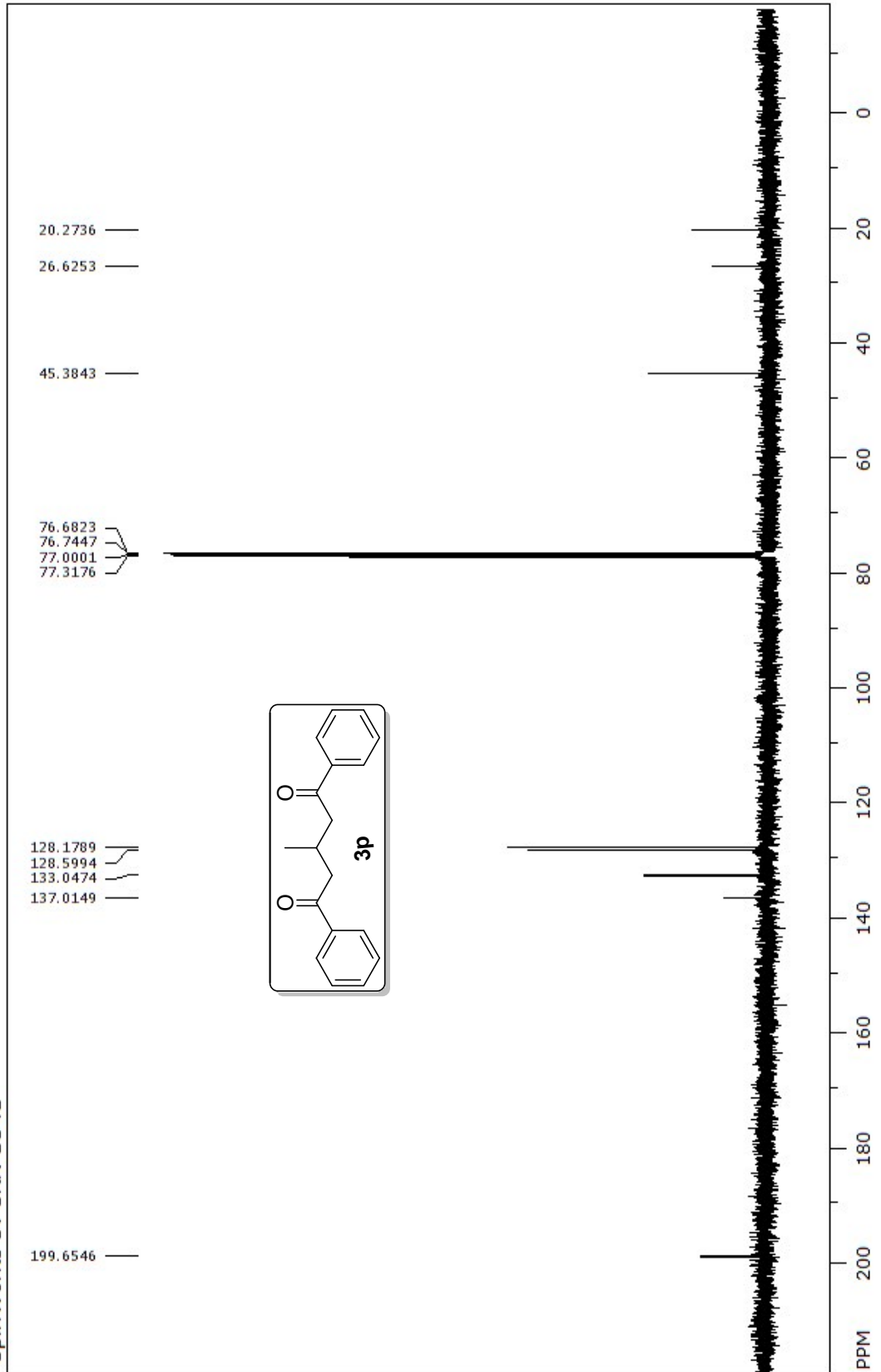

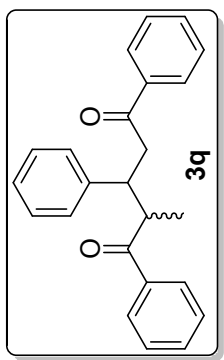
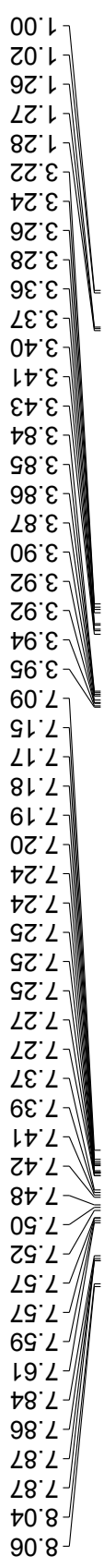

SRK-1510

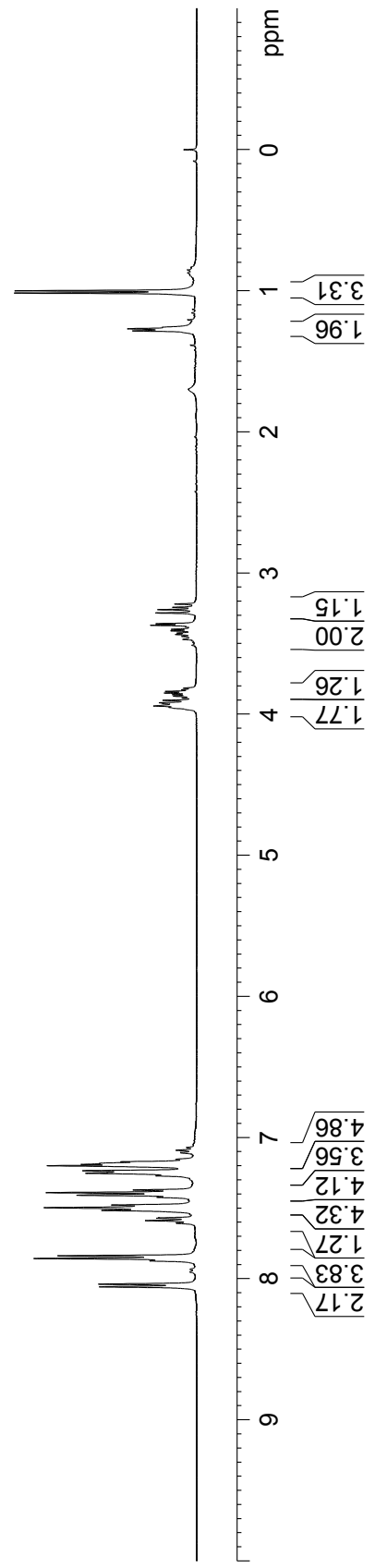

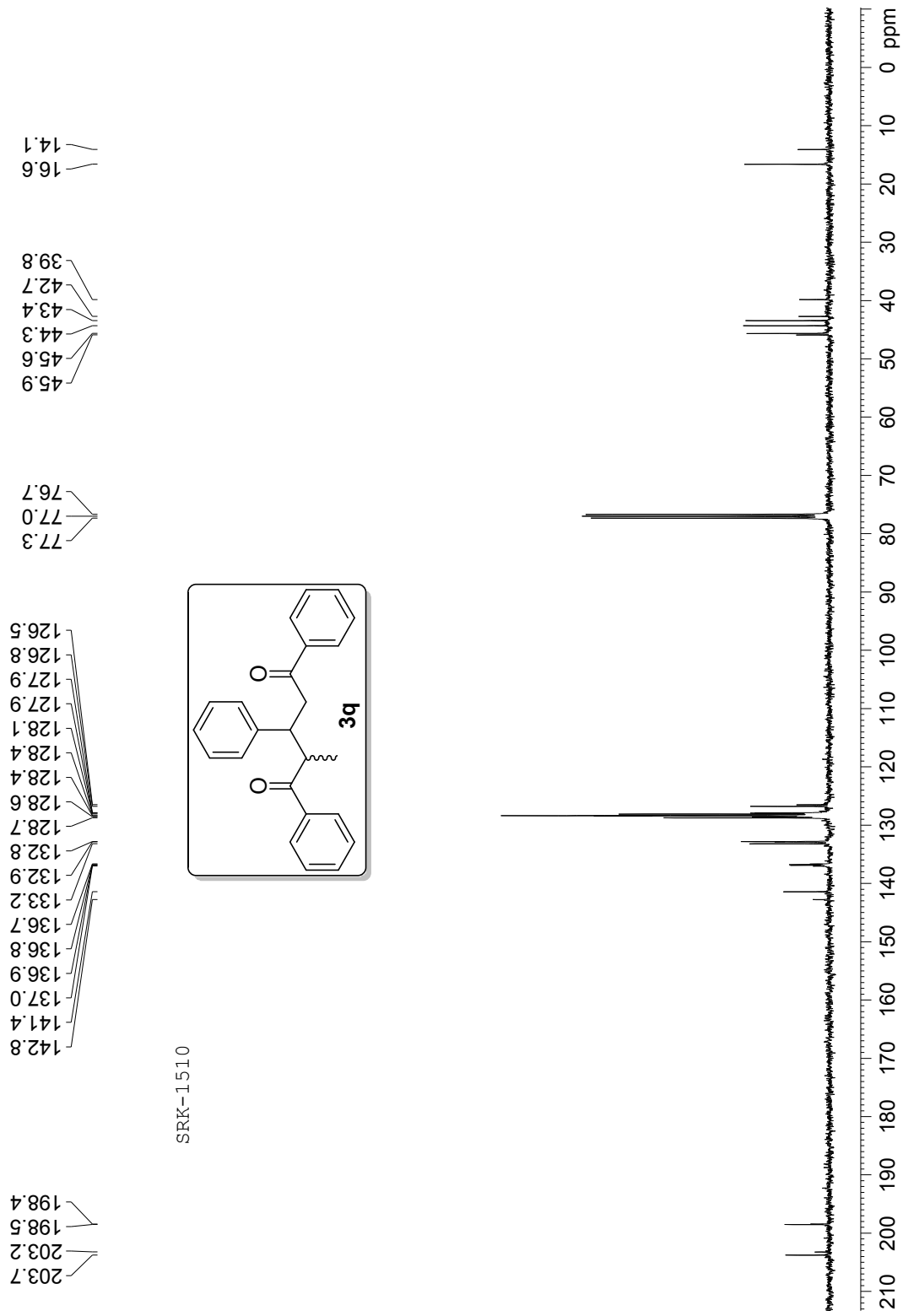

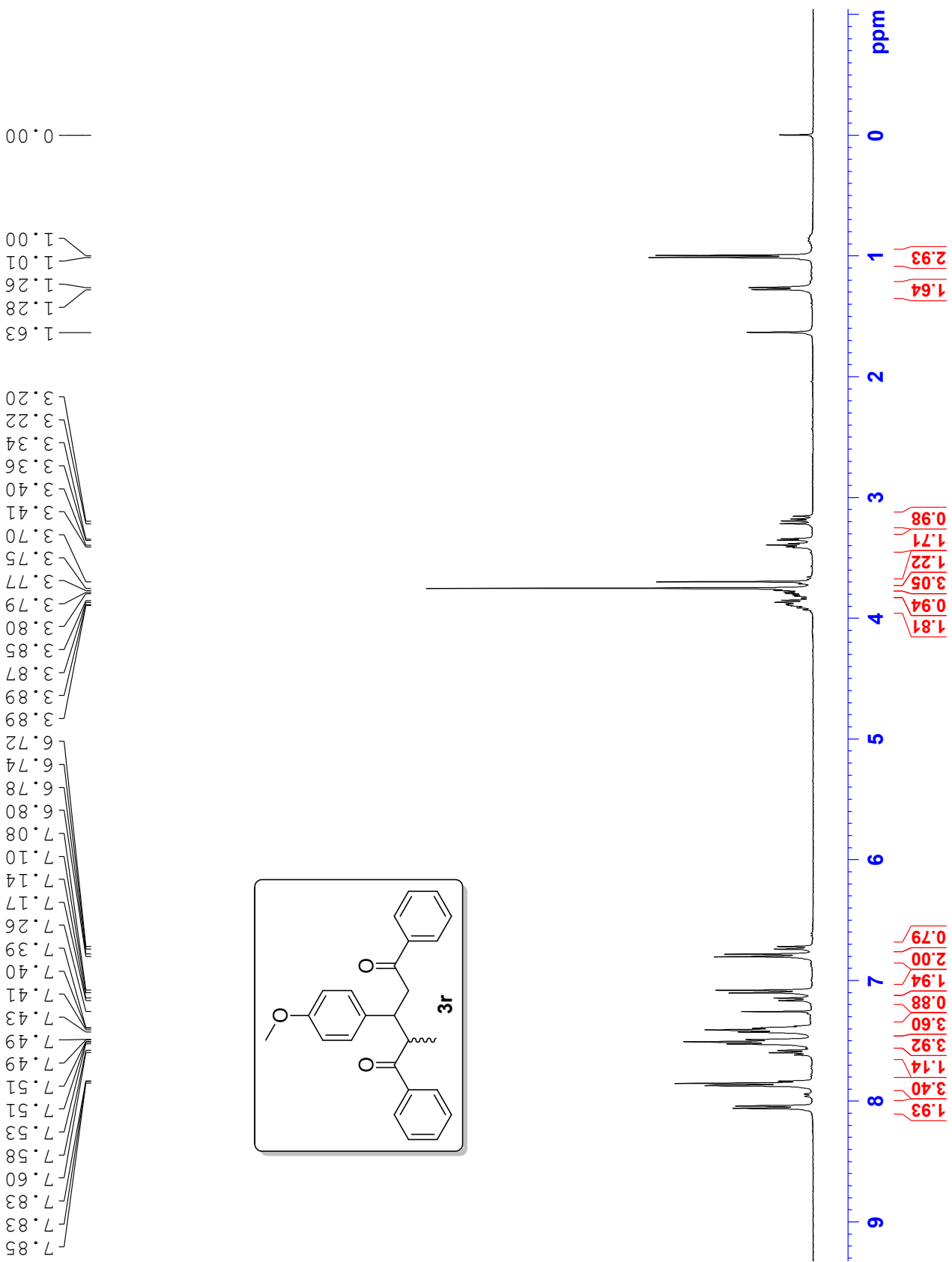

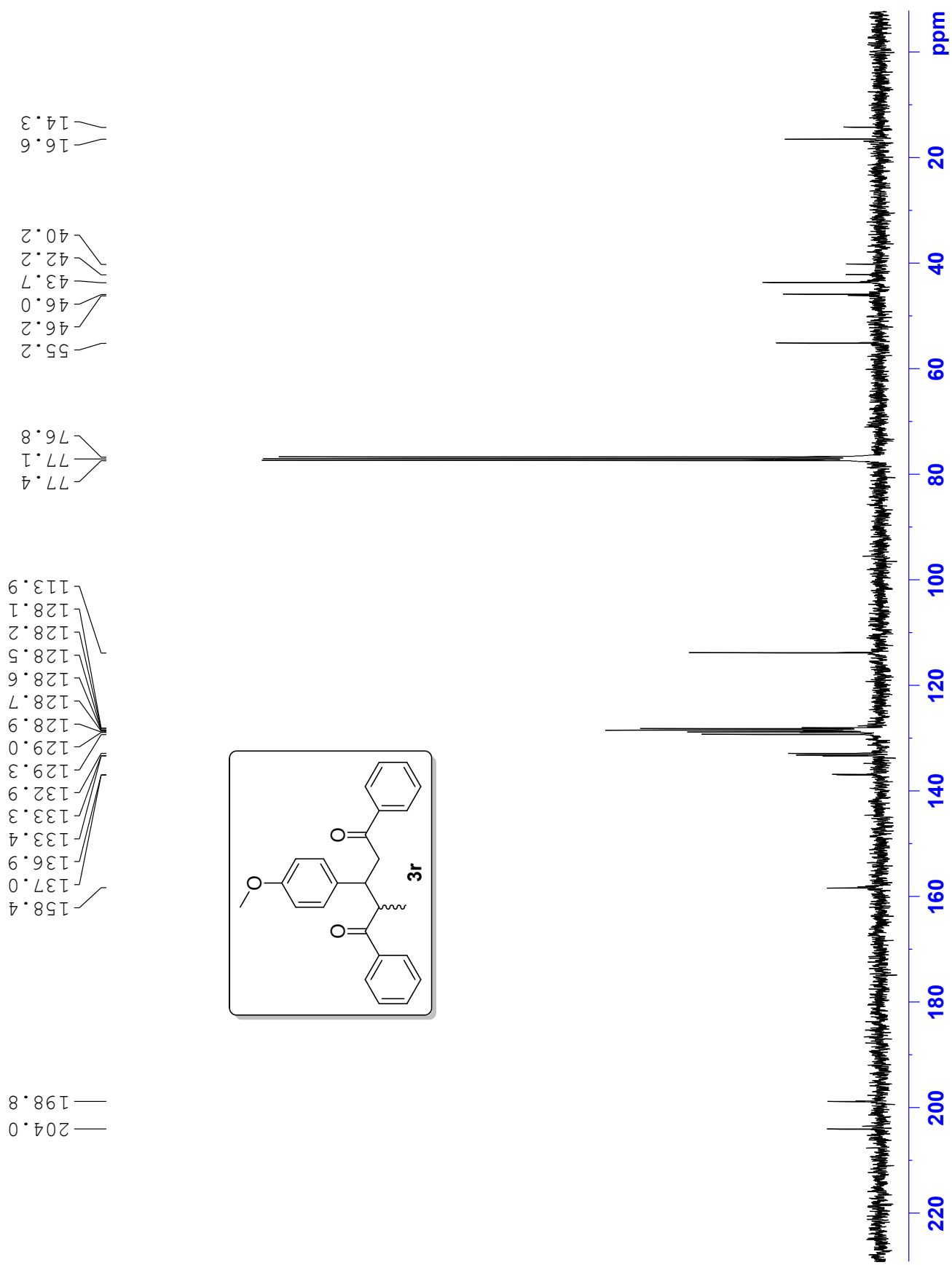

SpinWorks 3: SRK-1675

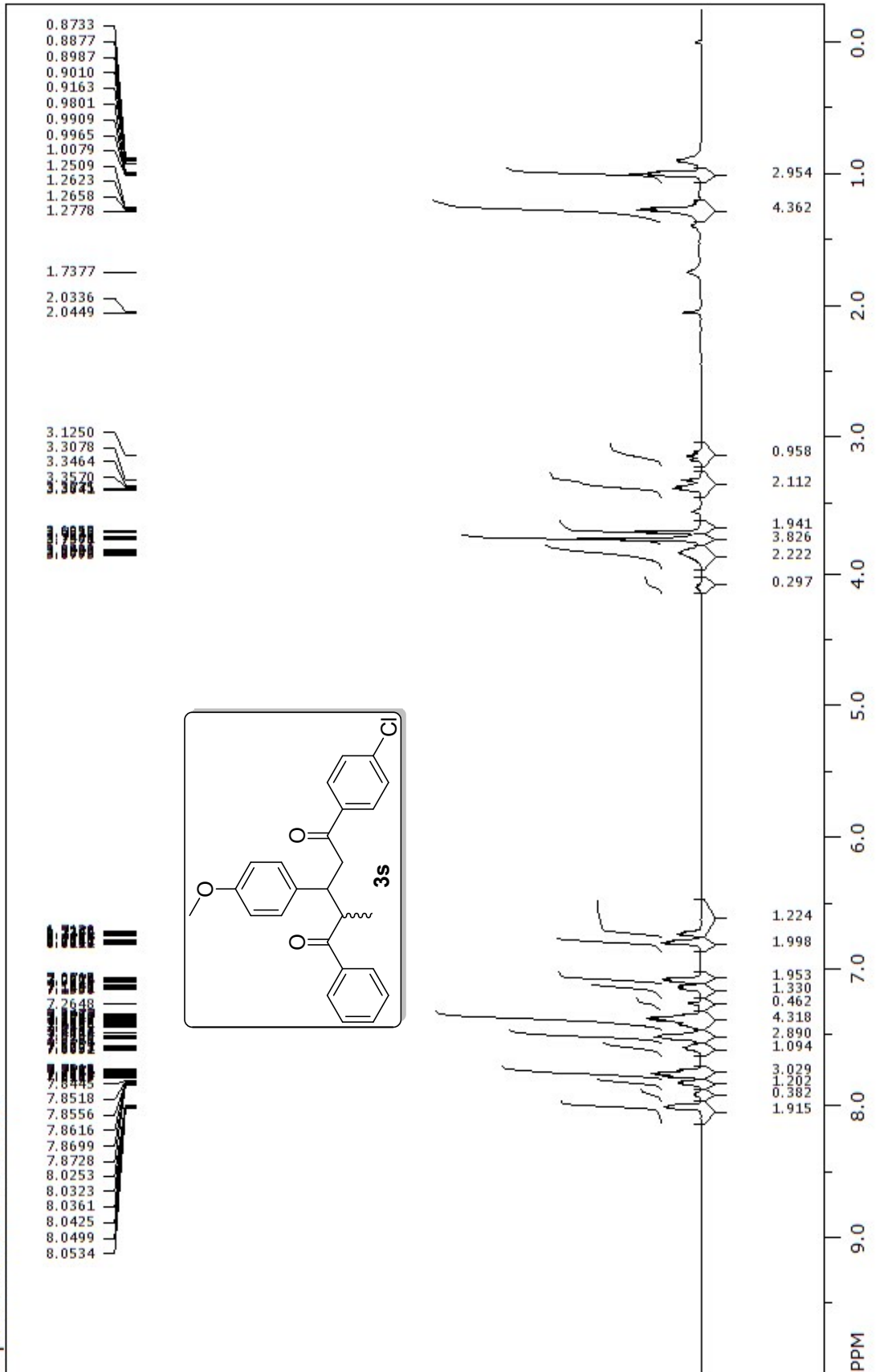

SpinWorks 3: SRK-1675

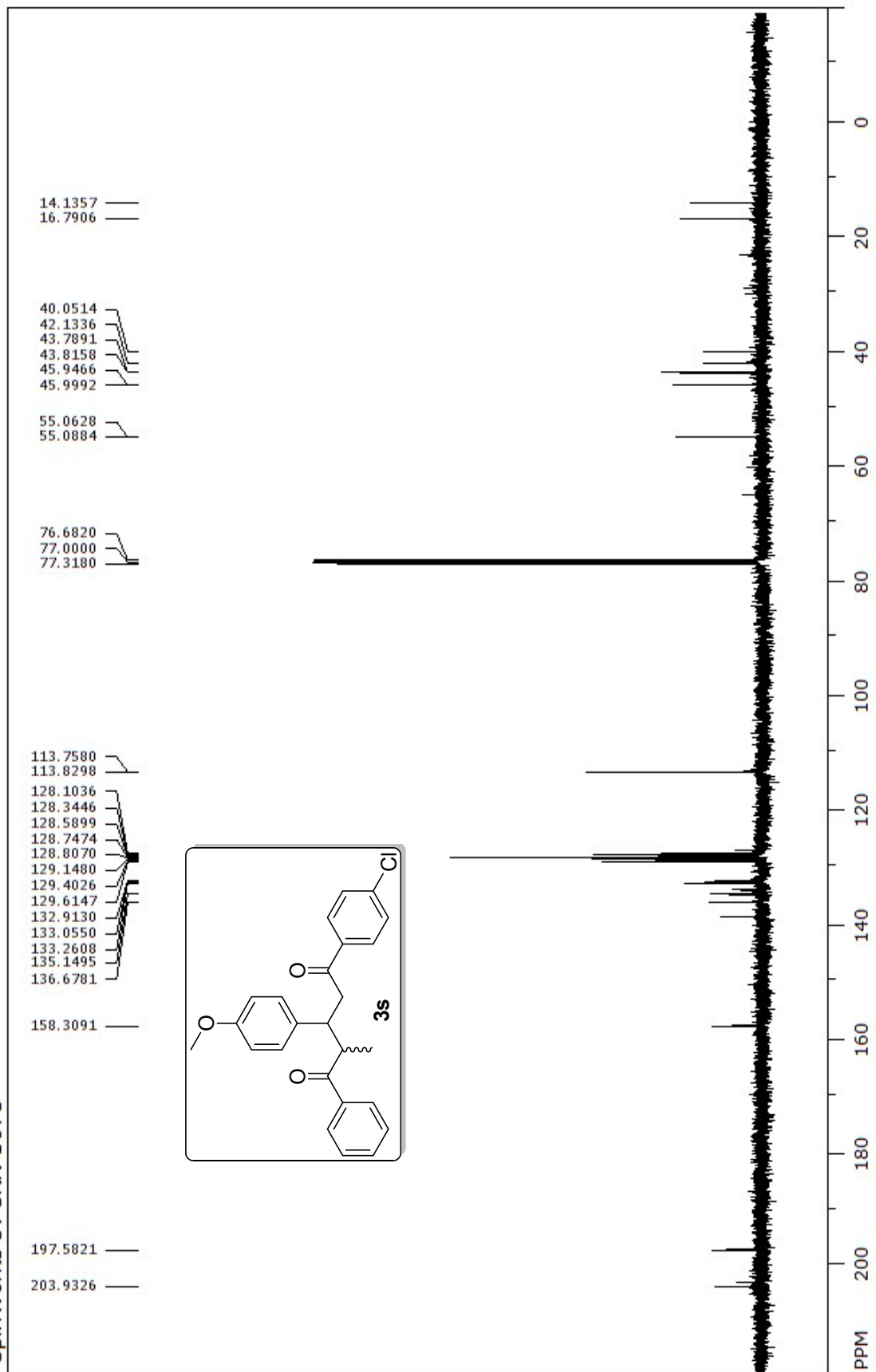

SpinWorks 3: SRK-1673-1

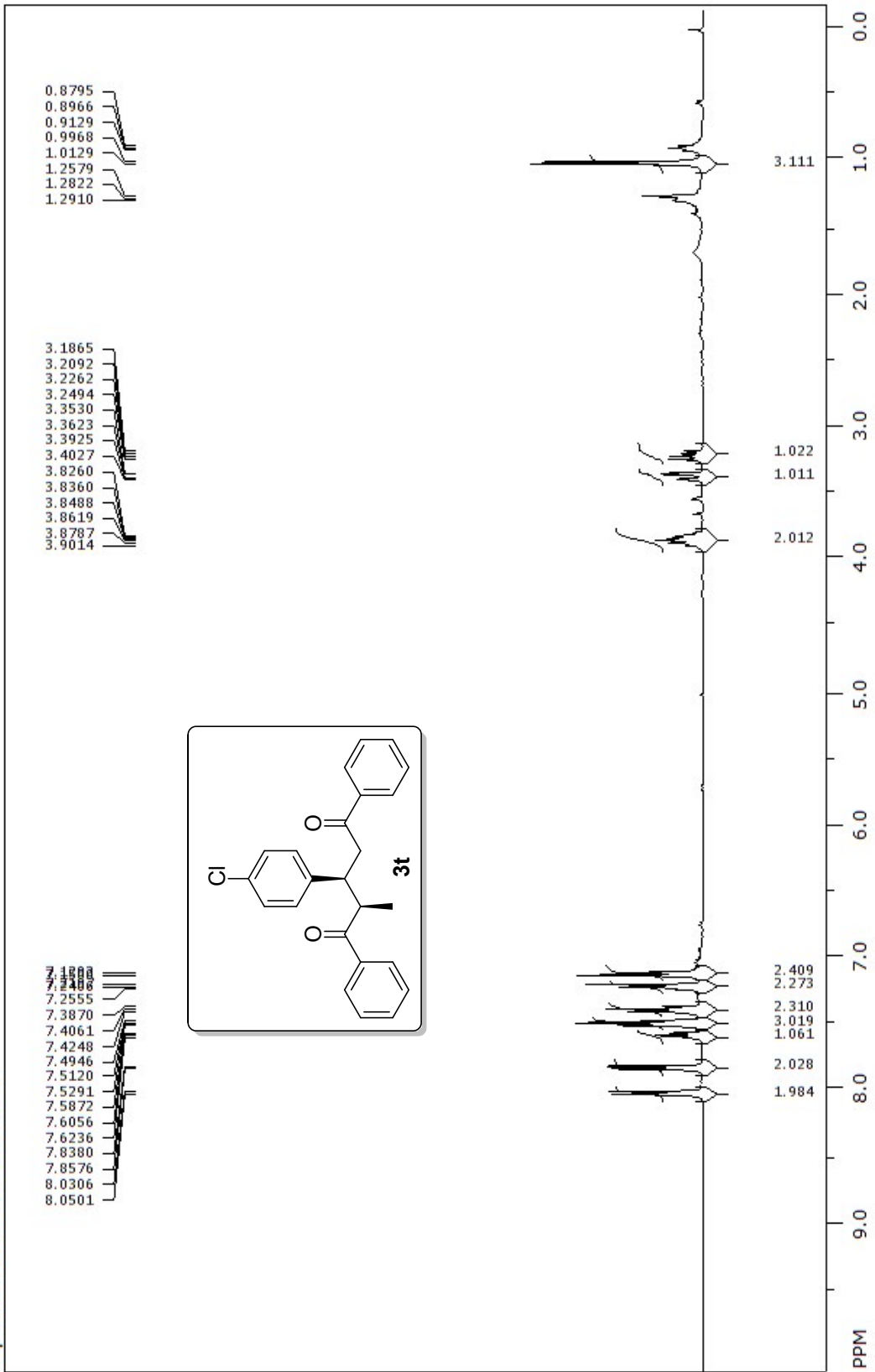



SpinWorks 3: SRK-1673-1

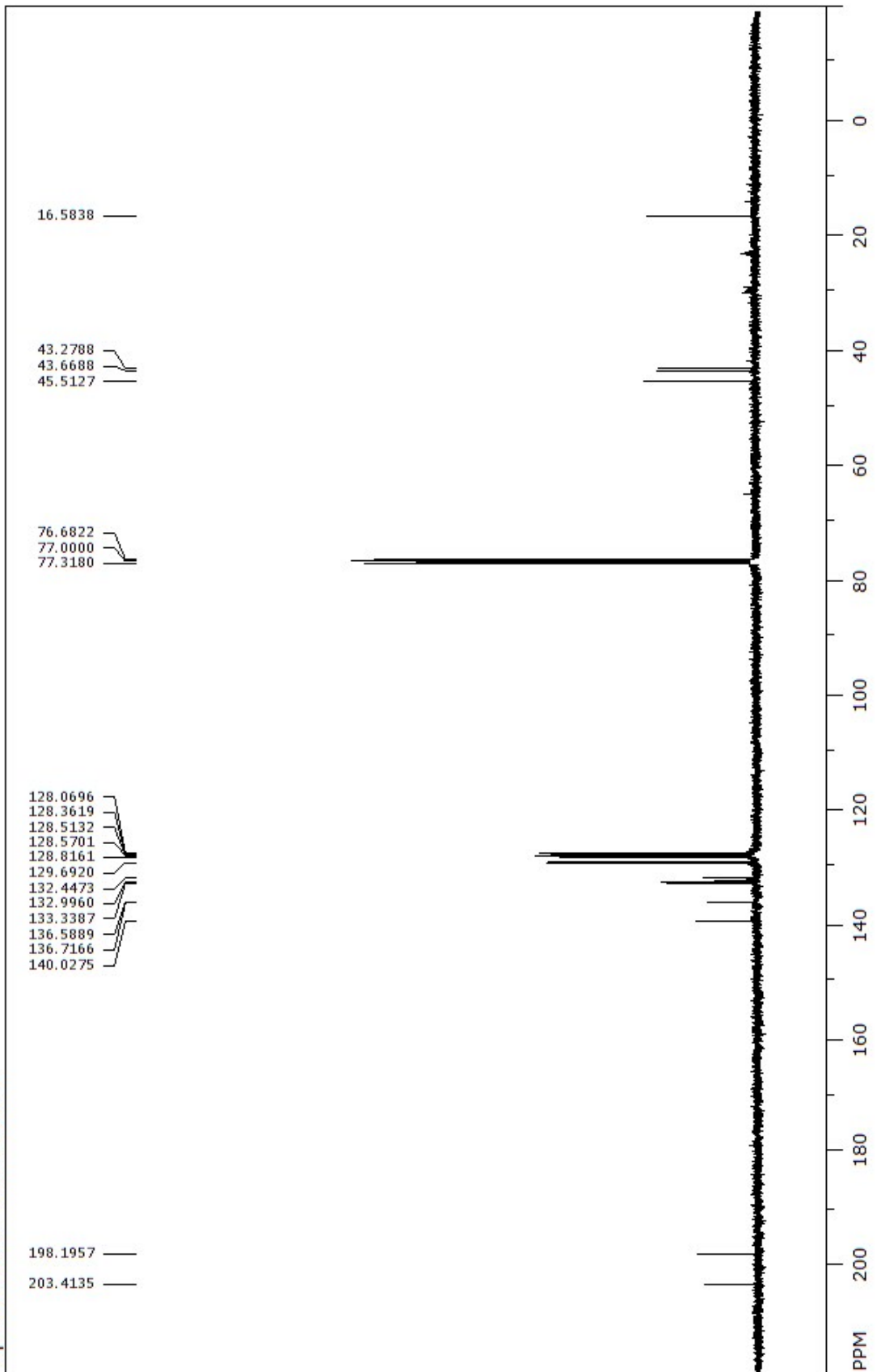

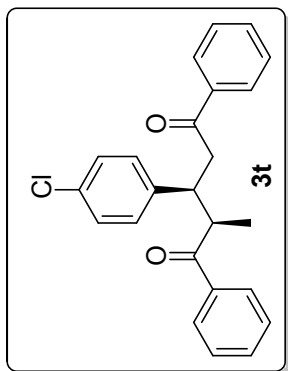

SpinWorks 3: SRK-1673-2

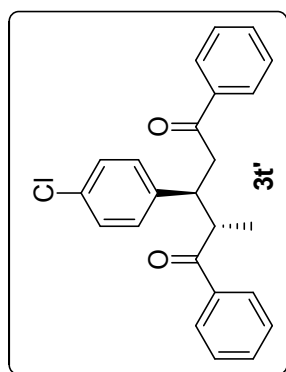
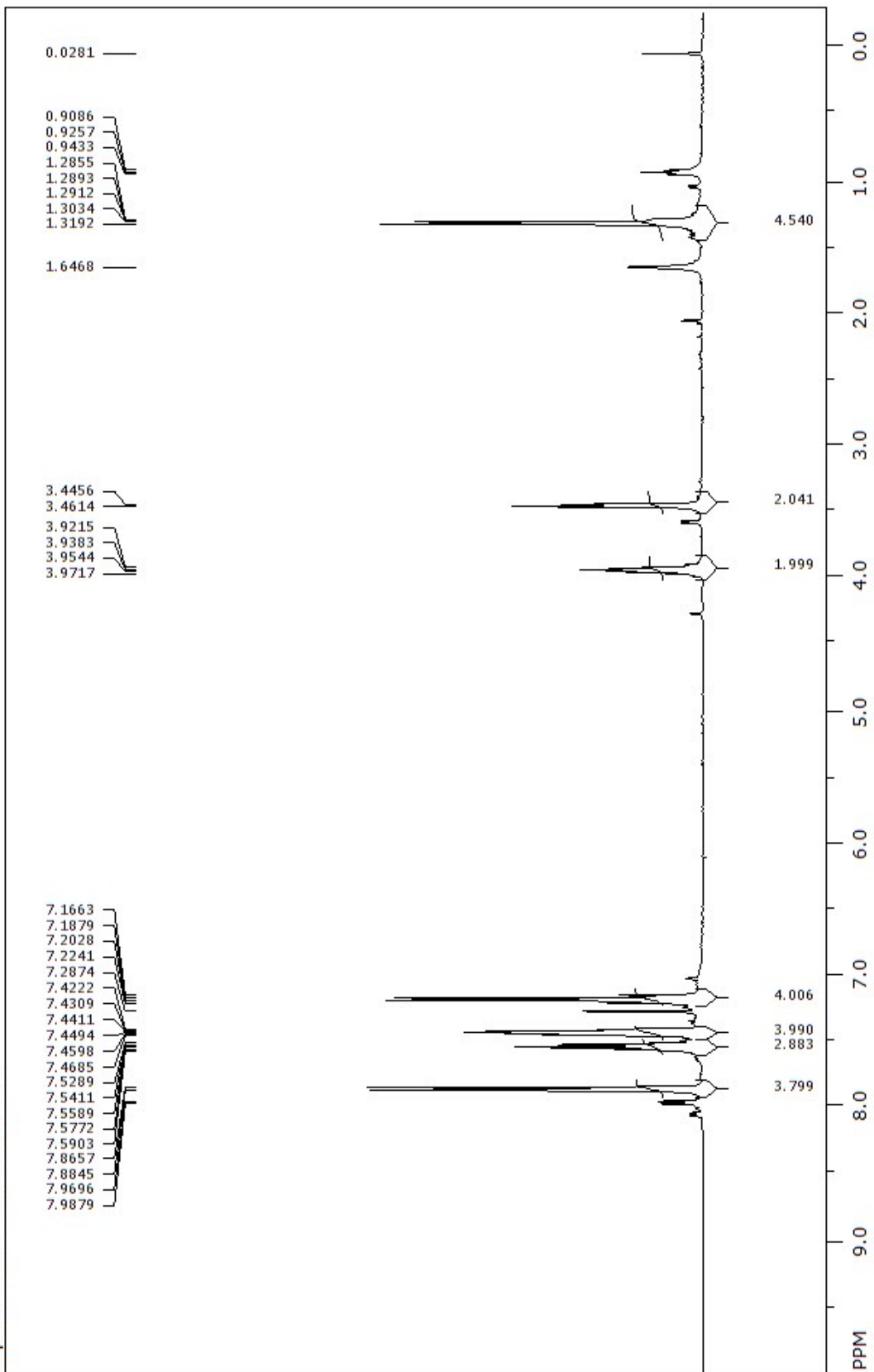



SpinWorks 3: SRK-1673-2

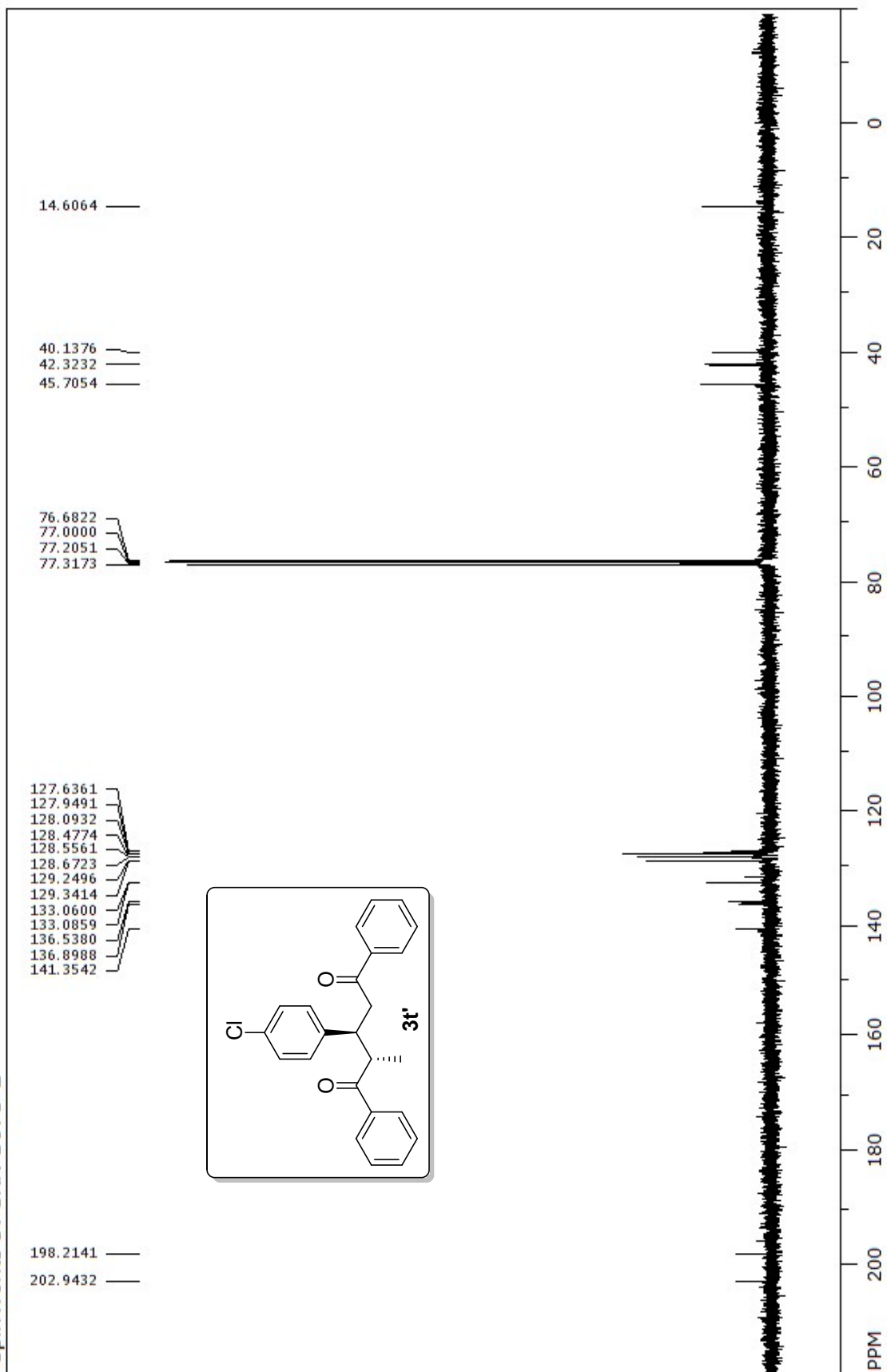

**NMR experiment for check the formation of acetal**

(1 equiv. Acetophenone, 1 equiv. TMOF, 0.5 equiv. TfOH)

**After 30 min; CDCl<sub>3</sub>:CCl<sub>4</sub> (1:1)**

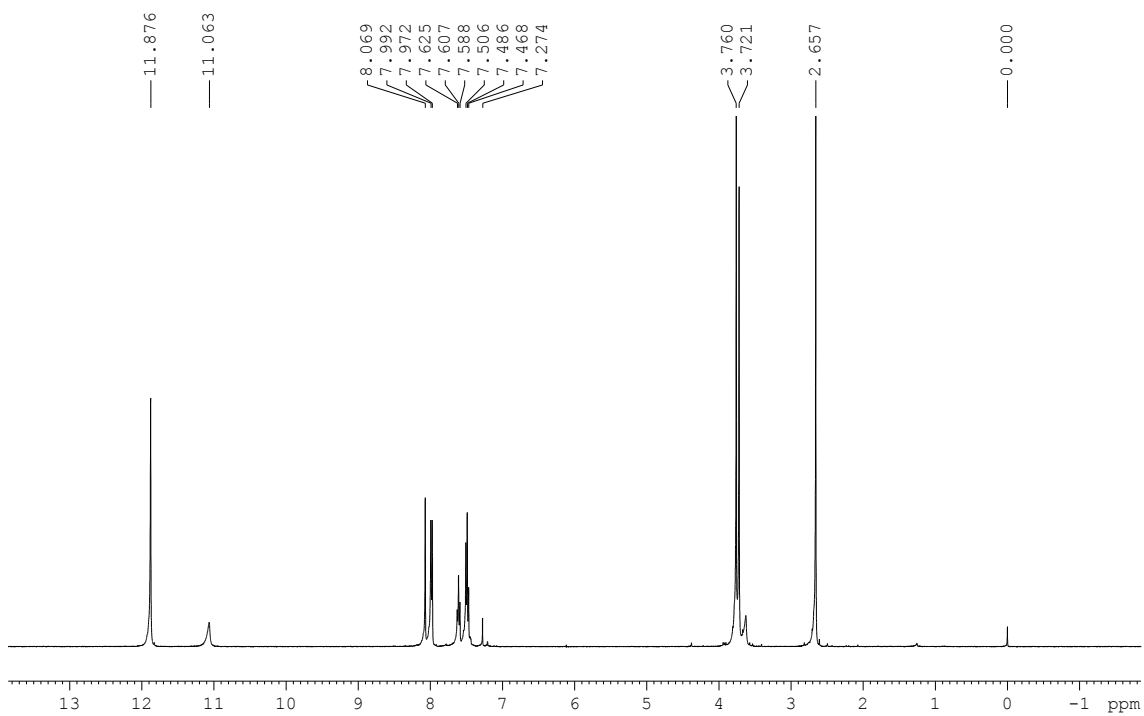

After 2 h; CDCl<sub>3</sub>:CCl<sub>4</sub> (1:1)

